



Enterprise IP Phone User Guide SIP-T23P & T23G

Copyright

Copyright © 2016 YEALINK NETWORK TECHNOLOGY CO., LTD

Copyright © 2016 Yealink Network Technology CO., LTD. All rights reserved. No parts of this publication may be reproduced or transmitted in any form or by any means, electronic or mechanical, photocopying, recording, or otherwise, for any purpose, without the express written permission of Yealink Network Technology CO., LTD. Under the law, reproducing includes translating into another language or format.

When this publication is made available on media, Yealink Network Technology CO., LTD. gives its consent to downloading and printing copies of the content provided in this file only for private use but not for redistribution. No parts of this publication may be subject to alteration, modification or commercial use. Yealink Network Technology CO., LTD. will not be liable for any damages arising from use of an illegally modified or altered publication.

Warranty

THE SPECIFICATIONS AND INFORMATION REGARDING THE PRODUCTS IN THIS GUIDE ARE SUBJECT TO CHANGE WITHOUT NOTICE. ALL STATEMENTS, INFORMATION, AND RECOMMENDATIONS IN THIS GUIDE ARE BELIEVED TO BE ACCURATE AND PRESENTED WITHOUT WARRANTY OF ANY KIND, EXPRESS OR IMPLIED. USERS MUST TAKE FULL RESPONSIBILITY FOR THEIR APPLICATION OF PRODUCTS.

YEALINK NETWORK TECHNOLOGY CO., LTD. MAKES NO WARRANTY OF ANY KIND WITH REGARD TO THIS GUIDE, INCLUDING, BUT NOT LIMITED TO, THE IMPLIED WARRANTIES OF MERCHANTABILITY AND FITNESS FOR A PARTICULAR PURPOSE. Yealink Network Technology CO., LTD. shall not be liable for errors contained herein nor for incidental or consequential damages in connection with the furnishing, performance, or use of this guide.

Declaration of Conformity



Hereby, Yealink Network Technology CO., LTD. declares that this phone is in conformity with the essential requirements and other relevant provisions of the CE, FCC.

You can find the CE and FCC information from the label on the back of the IP phone.

CE Mark Warning

This device is marked with the CE mark in compliance with EC Directives 2006/95/EC and 2004/108/EC.

Part 15 FCC Rules

This device is compliant with Part 15 of the FCC Rules. Operation is subject to the following two conditions:

1. This device may not cause harmful interference, and
2. This device must accept any interference received, including interference that may cause undesired

operation.

Class B Digital Device or Peripheral

Note: This device is tested and complies with the limits for a Class B digital device, pursuant to Part 15 of the FCC Rules. These limits are designed to provide reasonable protection against harmful interference in a residential installation. This equipment generates, uses, and can radiate radio frequency energy and, if not installed and used in accordance with the instructions, may cause harmful interference to radio communications. However, there is no guarantee that interference will not occur in a particular installation. If this equipment does cause harmful interference to radio or television reception, which can be determined by turning the equipment off and on, the user is encouraged to try to correct the interference by one or more of the following measures:

1. Reorient or relocate the receiving antenna.
2. Increase the separation between the equipment and receiver.
3. Connect the equipment into an outlet on a circuit different from that to which the receiver is connected.
4. Consult the dealer or an experienced radio/TV technician for help.

WEEE Warning



To avoid the potential effects on the environment and human health as a result of the presence of hazardous substances in electrical and electronic equipment, end users of electrical and electronic equipment should understand the meaning of the crossed-out wheeled bin symbol. Do not dispose of WEEE as unsorted municipal waste and have to collect such WEEE separately.

Customer Feedback

We are striving to improve our documentation quality and we appreciate your feedback. Email your opinions and comments to DocsFeedback@yealink.com.

GNU GPL INFORMATION

Yealink SIP-T23P/G IP phone firmware contains third-party software under the GNU General Public License (GPL). Yealink uses software under the specific terms of the GPL. Please refer to the GPL for the exact terms and conditions of the license.

The original GPL license, source code of components licensed under GPL and used in Yealink products can be downloaded online:

<http://www.yealink.com/GPLOpenSource.aspx?BaseInfoCatId=293&NewsCatId=293&CatId=293>.

About This Guide

Thank you for choosing the SIP-T23P/SIP-T23G (hereinafter referred to as SIP-T23P/G) IP phone, exquisitely designed to provide business telephony features, such as Call Hold, Call Transfer, Busy Lamp Field, Multicast Paging and Conference over an IP network. The difference between the SIP-T23P and SIP-T23G IP phones is that only SIP-T23G supports Gigabit network interface.

This guide provides everything you need to quickly use your new phone. First, verify with your system administrator that the IP network is ready for phone configuration. Also be sure to read the Packaging Contents and Regulatory Notices sections in this guide before you set up and use the SIP-T23P/G IP phone.

Note

Network Directory and Network Call Log features are hidden for IP phones in neutral firmware, which are designed for the BroadWorks environment. Please contact your system administrator for more information.

In This Guide

Topics provided in this guide include:

- Chapter 1 [Overview](#)
- Chapter 2 [Getting Started](#)
- Chapter 3 [Customizing Your Phone](#)
- Chapter 4 [Basic Call Features](#)
- Chapter 5 [Advanced Phone Features](#)

Summary of Changes

This section describes the changes to this guide for each release and guide version.

Changes for Release 80, Guide Version 80.95

The following section is new:

- [Entering Data and Editing Fields](#) on page 30

Major updates have occurred to the following sections:

- [Icon Instructions](#) on page 13

- [Optional Accessories](#) on page 22
- [Phone Installation](#) on page 23
- [Troubleshooting](#) on page 165
- [Appendix A - Time Zones](#) on page 177

Changes for Release 80, Guide Version 80.60

The following sections are new:

- [Shared Call Appearance \(SCA\)](#) on page 139
- [Bridged Line Appearance \(BLA\)](#) on page 152

Major updates have occurred to the following sections:

- [Icon Instructions](#) on page 13
- [LED Instructions](#) on page 14
- [Web User Interface](#) on page 17
- [Call Forward](#) on page 102

Changes for Release 80, Guide Version 80.20

The following sections are new:

- [Optional Accessories](#) on page 22
- [Short Message Service \(SMS\)](#) on page 158

Major updates have occurred to the following sections:

- [Web User Interface](#) on page 17
- [ReCall](#) on page 96
- [Time & Date](#) on page 37
- [Anonymous Call Rejection](#) on page 120
- [Intercom](#) on page 128
- [Multicast Paging](#) on page 131

Table of Contents

About This Guide	v
In This Guide	v
Summary of Changes	v
Changes for Release 80, Guide Version 80.95	v
Changes for Release 80, Guide Version 80.60	vi
Changes for Release 80, Guide Version 80.20	vi
Table of Contents	vii
Overview	11
Hardware Component Instructions	11
Icon Instructions	13
LED Instructions	14
User Interfaces	16
Phone User Interface	16
Web User Interface	17
Documentations	19
Getting Started	21
Packaging Contents	21
Optional Accessories	22
Phone Installation	23
Phone Initialization	26
Phone Status	26
Basic Network Settings	28
Registration	30
Idle Screen	30
Entering Data and Editing Fields	30
Customizing Your Phone	35
General Settings	35
Backlight	35
Contrast	36
Language	36
Time & Date	37
Administrator Password	39

Key as Send	40
Phone Lock	40
Audio Settings	43
Volume	43
Ring Tones	44
Contact Management	46
Directory	46
Local Directory	47
Blacklist	57
Remote Phone Book	59
Call History Management	61
System Customizations	63
Logo Customization	63
Headset Use	64
DSS Keys	66
Account Management	75
Dial Plan	77
Emergency Number	83
Live Dialpad	84
Hotline	85
Basic Call Features	87
Placing Calls	88
Answering Calls	90
Ending Calls	91
Redialing Numbers	91
Recent Call In Dialing	91
Auto Answer	93
Auto Redial	93
Call Completion	95
ReCall	96
Call Mute	96
Call Hold/Resume	97
Do Not Disturb (DND)	98
Call Forward	102
Call Transfer	109
Call Waiting	111
Conference	111
Local Conference	111
Network Conference	113
Call Park	114
Call Pickup	115
Anonymous Call	119
Anonymous Call Rejection	120

Advanced Phone Features.....	121
Busy Lamp Field (BLF)	121
BLF List	123
Call Recording	125
Hot Desking	127
Intercom	128
Outgoing Intercom Calls.....	128
Incoming Intercom Calls	129
Using Intercom	131
Multicast Paging.....	131
Sending RTP Stream	131
Receiving RTP Stream.....	134
Using Multicast Paging.....	135
Music on Hold.....	137
Automatic Call Distribution (ACD).....	137
Shared Call Appearance (SCA)	139
Configuring SCA Feature on the IP Phone	140
Using SCA Feature on the IP Phone.....	146
Bridged Line Appearance (BLA)	152
Configuring BLA Feature on the IP Phone	153
Using BLA Feature on the IP Phone.....	156
Messages.....	158
Short Message Service (SMS)	158
Voice Mail	161
Message Waiting Indicator (MWI)	162
Troubleshooting	165
General Issues.....	165
Display Issues	165
Password Issues.....	166
Call Issues	167
Headset & Handset Issues.....	167
Audio Issues	167
Log Issues.....	169
Reboot & Upgrade & Reset Issues.....	172
Regulatory Notices	175
Service Agreements	175
Limitations of Liability	175
Safety Instructions	175

Appendix A - Time Zones.....177

Index.....179

Overview

This chapter provides the overview of the SIP-T23P/G IP phone. Topics include:

- [Hardware Component Instructions](#)
- [Icon Instructions](#)
- [LED Instructions](#)
- [User Interfaces](#)
- [Documentations](#)



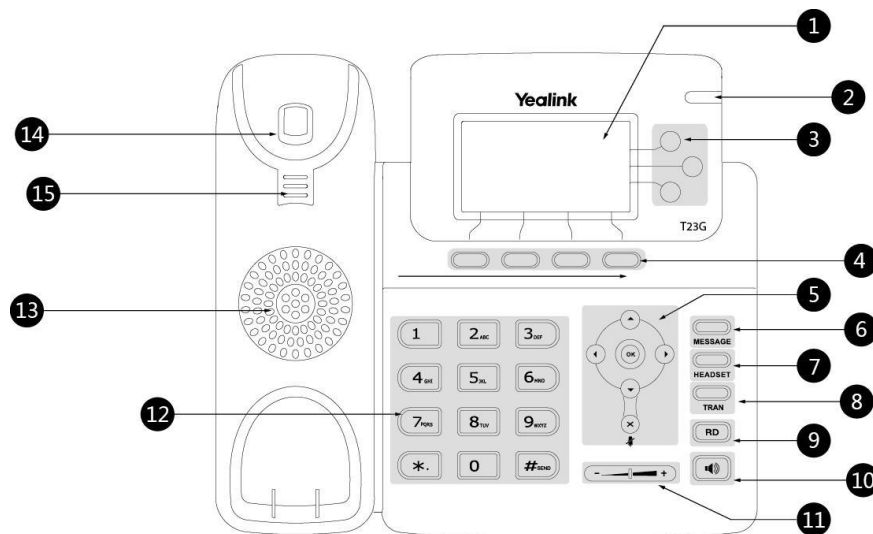

If you require additional information or assistance with your new phone, contact your system administrator.

Hardware Component Instructions

The main hardware components of the SIP-T23P/G IP phone are the LCD screen and the keypad.































Hardware component instructions of the SIP-T23P/G IP phone are:

	Item	Description
①	LCD Screen	Shows information about calls, messages, soft keys, time, date and other relevant data: <ul style="list-style-type: none"> • Call information—caller ID, call duration • Icons (for example, ) • Missed call text or second incoming caller information • Prompt text (for example, "Saving config file!") • Time and date
②	Power Indicator LED	Indicates phone power status and phone status. <ul style="list-style-type: none"> • Receives an incoming call—Fast flashing • Receives a voice mail or text message—Slow flashing
③	Line Keys	Use these keys to activate up to three accounts and assign various features.
④	Soft Key	Label automatically to identify their context-sensitive features.
⑤		Scroll through the displayed information.
		Confirms actions or answers incoming calls.
		Cancels actions, rejects incoming calls, mutes or un-mutes calls.
⑥	MESSAGE Key	Indicates and accesses voice mails.
⑦	HEADSET Key	Toggles the headset mode.
⑧	TRAN Key	Transfers a call to another party.
⑨	RD Key	Redials a previously dialed number.
⑩	Speakerphone Key	Toggles the hands-free speakerphone mode.
⑪	Volume Key	Adjusts the volume of the handset, headset, speaker, and ringer.
⑫	Keypad	Provides the digits, letters and special characters in context-sensitive applications.
⑬	Speaker	Provides hands-free (speakerphone) audio output.
⑭	Hookswitch	Picking up the handset from the handset cradle, the hookswitch bounces and the phone connects to the line, laying the handset down on the handset cradle, the phone disconnects from the line.
⑮	Hookswitch Tab	Secures the handset in the handset cradle when the IP phone is mounted vertically. For more information on how to adjust the hookswitch tab, refer to Yealink Wall Mount Quick Installation Guide for Yealink IP Phones .

Icon Instructions

Icons appearing on the LCD screen are described in the following table:

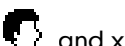
Icon	Description
	Network is unavailable
	The private line registers successfully
	Register failed
	Registering
	The shared/bridged line registers successfully
	Hands-free speakerphone mode
	Handset mode
	Headset mode
	Voice Mail
	Text Message
	Auto Answer
	Do Not Disturb
	Call Hold
	Ringer volume is 0
	Phone Lock
	Call Mute
	Received Calls
	Placed Calls

Icon	Description
	Missed Calls
	Call Forward/Forwarded Calls
	Recording box is full
	A call cannot be recorded
	Recording starts successfully
	Recording cannot be started
	Recording cannot be stopped
	The contact icon
	The ACD state is available
	The ACD state is unavailable
	The ACD state is Wrap up
	Log out of the ACD system

LED Instructions

Power Indicator LED

LED Status	Description
Solid red	The phone is initializing.
Fast flashing red (300ms)	The phone is ringing.
Slow flashing red (1s)	The phone receives a voice mail or text message.
Off	The phone is powered off. The phone is idle. The phone is busy. The call is placed on hold or is held. The call is muted.

Line key LED

LED Status	Description
Solid green	The line is seized. The line is in conversation.
Fast flashing green	The line receives an incoming call.
Slow flashing green	The call is placed on hold.
Off	The line is inactive.

Line key LED (configured as a BLF key or BLF List key)

LED Status	Description
Solid green	The monitored user is idle.
Fast flashing red (200ms)	The monitored user receives an incoming call.
Solid red	The monitored user is busy. The monitored user's conversation is placed on hold (This LED status requires server support).
Slow flashing red (1s)	The call is parked against the monitored user's phone number.
Off	The monitored user does not exist.

Line key LED (associated with a shared line)

The local SCA phone indicates the phone is involved in an SCA call, while the monitoring SCA phone indicates the phone is not involved in the SCA call.

LED Status	Description
Off	The shared line is idle.
Fast flashing green	The shared line receives an incoming call.
Solid green (for local SCA phone) Solid red (for monitoring SCA phone)	The shared line is in conversation. The shared line is dialing. The shared line is seized. The shared line conversation is barged in by the other shared line party.
Slow flashing green (for local SCA phone) Slow flashing red (for monitoring SCA phone)	The shared line conversation is placed on public hold.
Slow flashing green (for local SCA phone) Solid red (for monitoring SCA phone)	The shared line conversation is placed on private hold. For a multi-party call, all the shared line parties participating in this call place the shared line

LED Status	Description
	conversation on hold.

Line key LED (associated with a bridged line)

The local BLA phone indicates the phone is involved in a BLA call, while the monitoring BLA phone indicates the phone is not involved in the BLA call.

LED Status	Description
Off	The bridged line is idle.
Fast flashing green	The bridged line receives an incoming call.
Solid green (for local BLA phone) Solid red (for monitoring BLA phone)	The bridged line is in conversation. The bridged line is dialing. The bridged line is seized.
Slow flashing green (for local BLA phone) Slow flashing red (for monitoring BLA phone)	The bridged line conversation is placed on hold.

Note

The above introduces the default LED status. The statuses of the power indicator LED and BLF key are configurable via web user interface. For more information, refer to [Yealink_SIP-T2_Series_T19\(P\)_E2_T4_Series_CP860_IP_Phones_Administrator_Guide](#).

User Interfaces

Two ways to customize configurations of your SIP-T23P/G IP phone:

- The user interface on the IP phone.
- The user interface in a web browser on your PC.

The hardware components keypad and LCD screen constitute the phone user interface, which allows the user to execute all call operation tasks and basic configuration changes directly on the phone. In addition, you can use the web user interface to access all configuration settings. In many cases, either the phone user interface and/or the web user interface interchangeably. However, in some cases, it is only possible to use one or the other interface to operate the phone and change settings.

Phone User Interface

You can customize your phone by pressing the **Menu** soft key to access the phone user interface. The Advanced Settings option is only accessible to the administrator, and the default administrator password is "admin" (case-sensitive). For more information on customizing your phone with the available options from the phone user interface, refer

to [Customizing Your Phone](#) on page 35.

Web User Interface

In addition to the phone user interface, you can also customize your phone via web user interface. In order to access the web user interface, you need to know the IP address of your new phone. To obtain the IP address, press the OK key on the phone. Enter the IP address (e.g., <http://192.168.0.10> or 192.168.0.10) in the address bar of web browser on your PC. The default administrator user name and password are both “admin” (case-sensitive).

The options you can use to customize the IP phone via phone user interface and/or via web user interface are listed in the following table:

Options	Phone User Interface	Web User Interface
Status		
--IPv4		
--MAC		
--Firmware	√	√
--Network		
--Phone		
--Accounts		
Basic Phone Settings		
--Backlight	√	
--Contrast	√	
--Language	√	
--Time & Date	√	
--Administrator Password	√	
--Key as Send	√	
--Phone Lock	√	
--Ring Tones	√	
--Contact Management		
--Directory	x	√
--Local Directory	√	
--Blacklist	√	
--Remote Phone Book	x	
--Call History Management	√	
--Logo Customization	x	
--DSS Keys	√	
--Account Management	√	
--Dial Plan	x	
--Emergency Number	x	
--Live Dialpad	x	

Options	Phone User Interface	Web User Interface
--Hotline	√	
Basic Call Features		
--Recent Call In Dialing	x	
--Auto Answer	√	
--Auto Redial	√	
--Call Completion	√	
--ReCall	√	
-- Do Not Disturb (DND)	√	
--Call Forward	√	√
--Call Transfer	√	
--Call Waiting	√	
--Conference	x	
--Call Park	√	
--Call Pickup	√	
--Anonymous Call	√	
--Anonymous Call Rejection	√	
Advanced Phone Features		
--Busy Lamp Field (BLF)	√	
--BLF List	x	
--Call Recording	√	
--Hot Desking	√	
--Intercom	√	
--Multicast Paging	x	√
--Music on Hold	x	
--Automatic Call Distribution (ACD)	x	
--Shared Call Appearance (SCA)	x	
--Bridged Line Appearance (BLA)	x	
--Messages	√	
SIP Account		
--User Options	x	
--Active Line	√	
--Label	√	
--Display Name	√	
--Register Name	√	
--User Name	√	√
--Password	√	
--Server Options		
--SIP Server 1/2	√	
--Register Port	x	
--Outbound Status	√	
--Outbound Proxy1/2	√	

Options	Phone User Interface	Web User Interface
--Proxy Fallback Interval	√	
--NAT Status	√	

Note

The table above lists most of the feature options. Please refer to the relevant sections for more information.

Documentations

The following table shows documentations available for the SIP-T23P/G IP phone.

Name	Contents	Where found	Language
Quick Start Guide	Basic call features and phone customizations	In the package	English
		On the website	English/Chinese
User Guide	Phone/Web user interface settings Basic call features and advanced phone features	On the website	English/Chinese

Note

You can also download the latest documentations online:

<http://support.yealink.com/documentFront/forwardToDocumentDetailPage?documentId=33>.

Getting Started

This chapter provides basic installation instructions and information for obtaining the best performance with the SIP-T23P/G IP phone. Topics include:

- [Packaging Contents](#)
- [Phone Installation](#)
- [Phone Initialization](#)
- [Phone Status](#)
- [Basic Network Settings](#)
- [Registration](#)
- [Idle Screen](#)
- [Entering Data and Editing Fields](#)

If you require additional information or assistance with your new phone, contact your system administrator.

Packaging Contents

The following components are included in your SIP-T23P/G IP phone package:

- **SIP-T23P/G IP Phone**

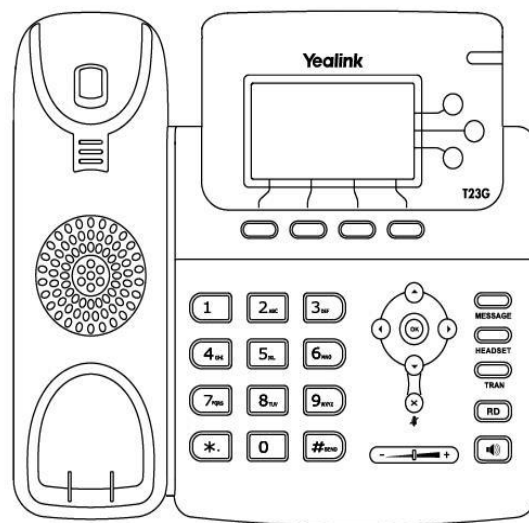

- **Phone Stand**

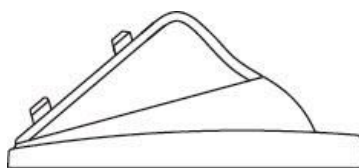

- **Handset & Handset Cord**

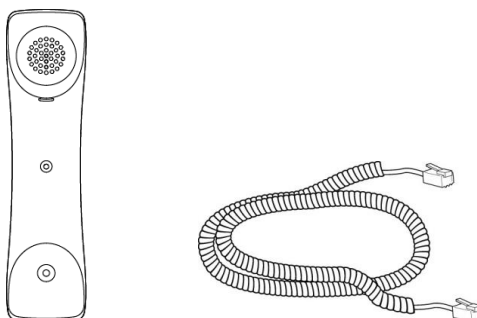

- **Ethernet Cable**

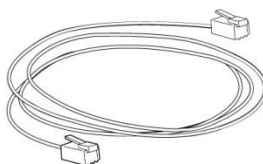

- **Quick Start Guide**

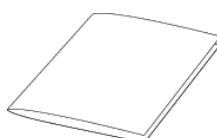

Check the list before installation. If you find anything missing, contact your system administrator.

Optional Accessories

The following items are optional accessories for your SIP-T23P/G IP phone. You need to purchase them separately if required.

- **Power Adapter**

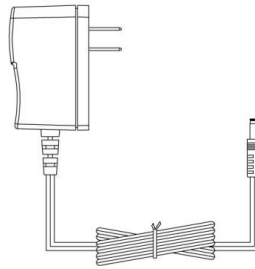

- **Headset**

**Note**

We recommend that you use the accessories provided or approved by Yealink. The use of unapproved third-party accessories may result in reduced performance.

Phone Installation

If your phone is already installed, proceed to [Phone Initialization](#) on page 26.

This section introduces how to install the phone:

- 1) Attach the stand
- 2) Connect the handset and optional headset
- 3) Connect the network and power

1) Attach the stand

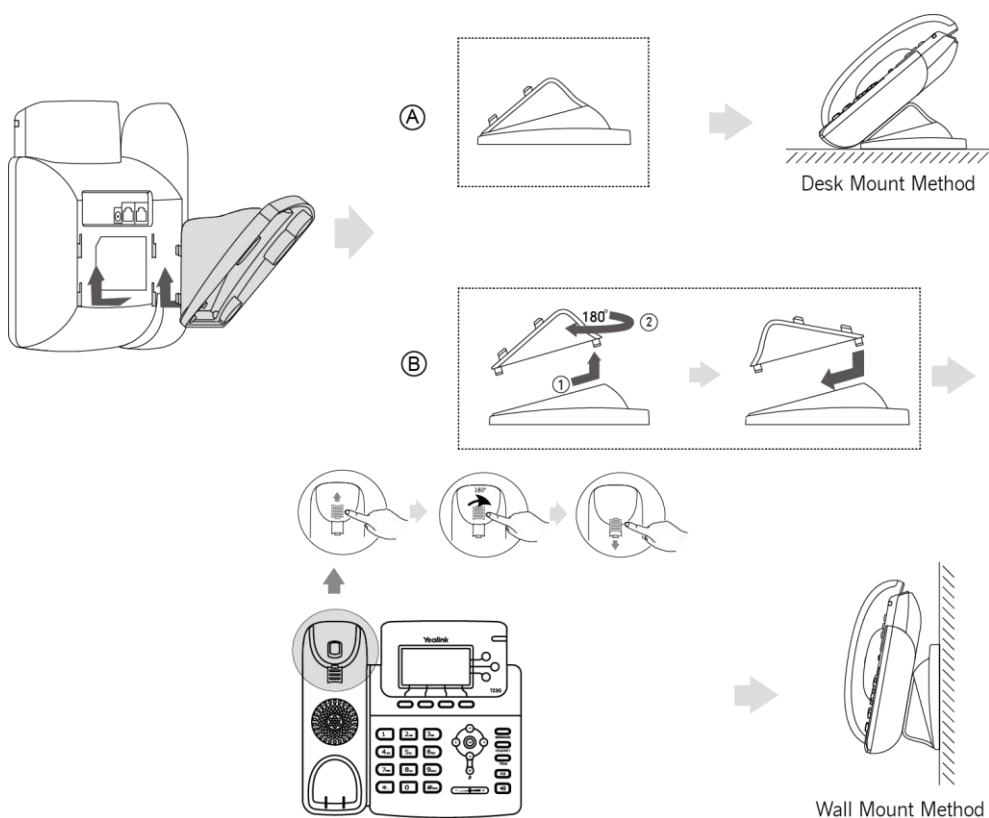

Note The hookswitch tab has a lip which allows the handset to stay on-hook when the IP phone is mounted vertically.

2) Connect the handset and optional headset

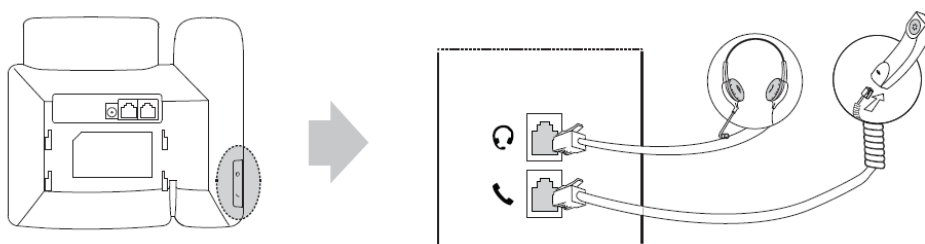

3) Connect the network and power

You have two options for power and network connections. Your system administrator will advise you which one to use.

- AC power
- Power over Ethernet (PoE)

AC Power

To connect the AC power:

1. Connect the DC plug on the power adapter to the DC5V port on the phone and connect the other end of the power adapter into an electrical power outlet.
2. Connect the included or a standard Ethernet cable between the Internet port on the phone and the one on the wall or switch/hub device port.

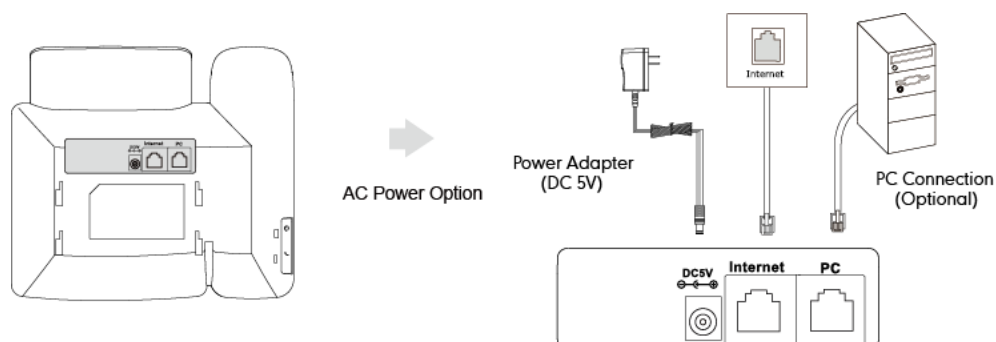

Note

The IP phone should be used with Yealink original power adapter (5V/600mA) only. The use of the third-party power adapter may cause the damage to the phone.

Power over Ethernet

With the included or a regular Ethernet cable, the SIP-T23P/G IP phone can be powered from a PoE-compliant switch or hub.

To connect the PoE for the SIP-T23P/G IP phone:

1. Connect the Ethernet cable between the Internet port on the phone and an available port on the in-line power switch/hub.

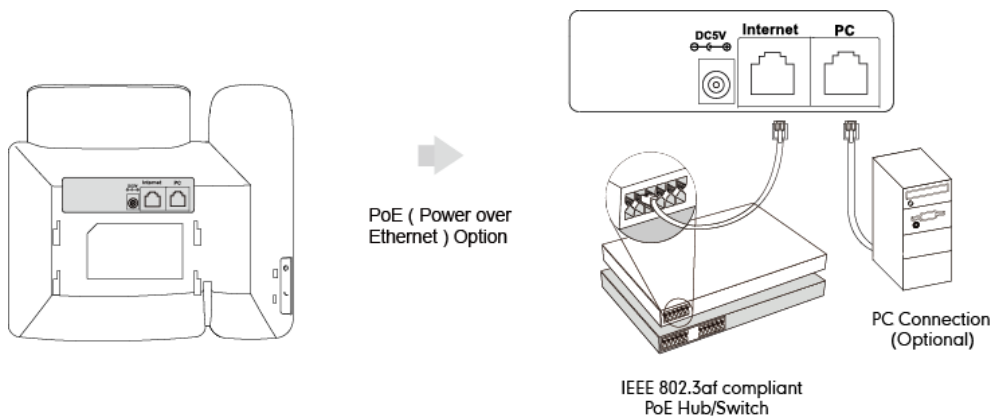

Note If in-line power is provided, you don't need to connect the phone to the power adapter. Make sure the switch/hub is PoE-compliant.

The phone can also share the network with another network device such as a PC (personal computer). This is an optional connection.

Important! Do not remove power from the phone while it is updating firmware and configurations.

Phone Initialization

After your phone is powered on, the system boots up and performs the following steps:

Automatic Phone Initialization

The phone finishes the initialization by loading the saved configuration. The LCD screen displays "Welcome Initializing...please wait" during this process.

DHCP (Dynamic Host Configuration Protocol)

The phone attempts to contact a DHCP server in your network to obtain valid IPv4 network settings (e.g., IP address, subnet mask, default gateway address and DNS address) by default.

Note If your network does not use DHCP, proceed to [Basic Network Settings](#) on page 28.

Phone Status

You can view phone status via phone user interface or web user interface.

Available information of phone status includes:



- Network status (e.g., IPv4 status, IP mode and MAC address).

- Phone status (e.g., product name, hardware version, firmware version, product ID, MAC address and device certificate status).
- Account status (e.g., register status of SIP accounts).

Note

You can view device certificate status via phone user interface only.

To view the phone status via phone user interface:

1. Press , or press **Menu->Status**.
2. Press  or  to scroll through the list and view the specific information.

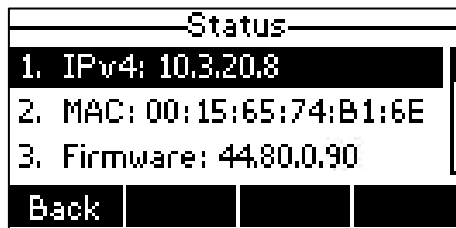
**To view the phone status via web user interface:**

1. Open a web browser of your computer.
2. Enter the IP address in the browser's address bar, and then press the **Enter** key.
3. Enter the user name (admin) and password (admin) in the login page.

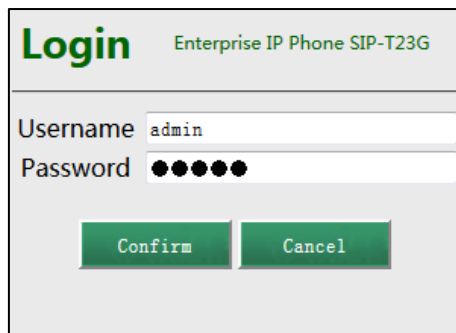

4. Click **Confirm** to login.

The phone status is displayed on the first page of the web user interface.

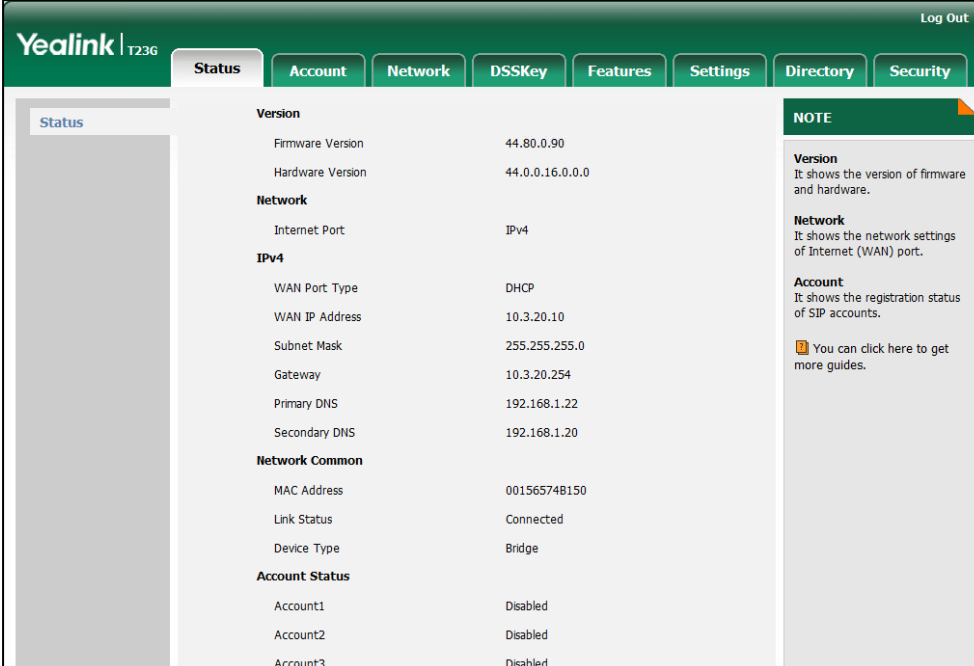

The screenshot shows the Yealink T23G web user interface. The top navigation bar includes 'Status', 'Account', 'Network', 'DSSKey', 'Features', 'Settings', 'Directory', and 'Security'. The 'Status' page is active, displaying the following information:

Version	
Firmware Version	44.80.0.90
Hardware Version	44.0.0.16.0.0.0
Network	
Internet Port	IPv4
IPv4	
WAN Port Type	DHCP
WAN IP Address	10.3.20.10
Subnet Mask	255.255.255.0
Gateway	10.3.20.254
Primary DNS	192.168.1.22
Secondary DNS	192.168.1.20
Network Common	
MAC Address	00156574B150
Link Status	Connected
Device Type	Bridge
Account Status	
Account1	Disabled
Account2	Disabled
Account3	Disabled

A 'NOTE' section on the right provides additional context:

- Version:** It shows the version of firmware and hardware.
- Network:** It shows the network settings of Internet (WAN) port.
- Account:** It shows the registration status of SIP accounts.

A link is provided: [You can click here to get more guides.](#)

Basic Network Settings

If your phone cannot contact a DHCP server for any reason, you need to configure network settings manually. The IP phone can support either or both IPv4 and IPv6 addresses.

To configure the IP mode via phone user interface:

1. Press **Menu->Settings->Advanced Settings** (default password: admin) **->Network->WAN Port**.
2. Press **◀** or **▶** to select **IPv4**, **IPv6** or **IPv4 & IPv6** from the **IP Mode** field.

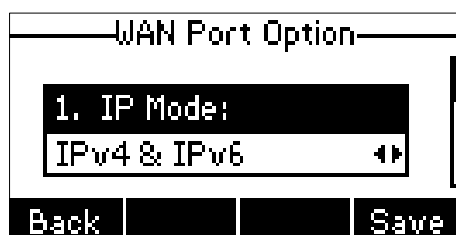



3. Press the **Save** soft key to accept the change or the **Back** soft key to cancel.

You can configure a static IPv4 address for the IP phone. Before configuring it, make sure that the IP mode is configured as **IPv4** or **IPv4 & IPv6**.

To configure a static IPv4 address via phone user interface:

1. Press **Menu->Settings->Advanced Settings** (default password: admin) **->Network->WAN Port**.

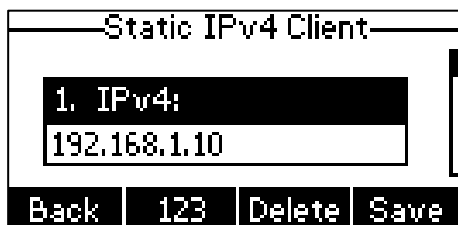

2. Press  to select the **IPv4** and then press the **Enter** soft key.
3. Press  to select **Static IPv4 Client** and then press the **Enter** soft key.
4. Enter the desired value in the **IPv4**, **Subnet Mask**, **Default Gateway**, **IPv4 Pri.DNS** and **IPv4 Sec.DNS** field respectively.



5. Press the **Save** soft key to accept the change or the **Back** soft key to cancel.

You can configure a static IPv6 address for the IP phone. Before configuring it, make sure that the IP mode is configured as **IPv6** or **IPv4 & IPv6**.

To configure a static IPv6 address via phone user interface:



1. Press **Menu->Settings->Advanced Settings** (default password: admin)
->**Network->WAN Port**.
2. Press  to select **IPv6** and then press the **Enter** soft key.
3. Press  to select **Static IPv6 Client** and then press the **Enter** soft key.
4. Enter the desired value in the **IPv6 IP**, **IPv6 IP Prefix**, **Default Gateway**, **IPv6 Pri.DNS** and **IPv6 Sec.DNS** field respectively.



5. Press the **Save** soft key to accept the change or the **Back** soft key to cancel.

If you are using an xDSL modem, you can connect your phone to the Internet via PPPoE mode. Set the WAN port as a PPPoE port. The PPPoE port will perform a PPP negotiation to obtain the IP address. Contact your system administrator for the PPPoE user name and password.

To configure PPPoE via phone user interface:

1. Press **Menu->Settings->Advanced Settings** (default password: admin)
->**Network->WAN Port**.
2. Press  to select **IPv4** and then press the **Enter** soft key.
3. Press  to select **PPPoE IPv4 Client** and then press the **Enter** soft key.

- Enter the user name and password in the corresponding fields.



- Press the **Save** soft key to accept the change or the **Back** soft key to cancel.

Note

The wrong network settings may result in inaccessibility of your phone and may also have an impact on your network performance. For more information on these parameters, contact your system administrator.

Registration

Generally, your phone will be deployed with multiple other phones. In this case, your system administrator will configure the phone parameters beforehand, so that after you start up your phone, the phone will be registered and ready for use. The SIP-T23P/G IP phone supports up to 3 accounts. If your phone is not registered, you may have to register it. For more information on how to register your phone, refer to [Account Management](#) on page 75.

Idle Screen

If the phone has successfully started up, the idle LCD screen will be displayed as below.

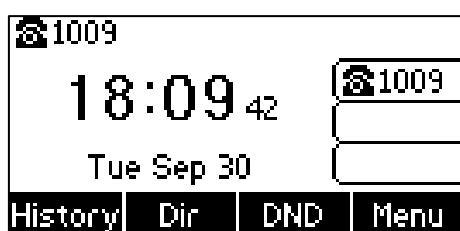

The idle screen displays the label of current account, time and date, and four soft keys.













Entering Data and Editing Fields

You can enter data and edit fields using the phone keypad.

Keypad on the phone provides different characters (or numbers) when using the **2aB**, **abc**, **Abc**, **ABC** or **123** input mode. You can change the following input modes to enter data and edit fields on your phone. When your phone keypad matches the input mode, you can press the keypad repeatedly to view the character (or numbers) options and











stop to select. When the character (or numbers) you want to enter displays in the field, wait one second, and enter the next character (or numbers).



The following table lists the input modes and character (or numbers) options for the keypad:

Input Mode Keypad	2aB	abc	Abc	ABC	123
	1				1
	2abcABC	abc2äæå àáâãç	abc2äæå àááãç	ABC2ÄÆÅ ÀÁÂÃÇ	2
	3defDEF	def3èéêë ð	def3èéêë ð	DEF3ÈÉÊË Ð	3
	4ghiGHI	ghi4íîï	ghi4íîï	GHI4ÌÍÏ	4
	5jklJKL	jkl5£	jkl5£	JKL5£	5
	6mnoMN O	mno6öøò óôõñ	mno6öøò óôõñ	MNO6ÖØÒ ÓÔÕÑ	6
	7pqrsPQR S	pqrs7ß	pqrs7ß	PQRS7ß	7
	8tuvTUV	tuv8ùúûü	tuv8ùúûü	TUV8ÙÚÛÜ Û	8
	9wxyzWX YZ	wxyz9ýþ	wxyz9ýþ	WXYZ9ÝÞ	9
	0	space	space	space	0
	*.,?! \-()@/: _ ; + & % = < > £ \$ ¥ € [] {} ~ ^ ¡ ¢ § # "	*.,?! \-()@/: _ ; + & % = < > £ \$ ¥ € [] {} ~ ^ ¡ ¢ § # "	*.,?! \-()@/: _ ; + & % = < > £ \$ ¥ € [] {} ~ ^ ¡ ¢ § # "	*.,?! \-()@/: _ ; + & % = < > £ \$ ¥ € [] {} ~ ^ ¡ ¢ § # "	. * : / @ []
	#	#	#	#	#

To enter or edit data:

Do one of the following:

If you want to	Then you can
<p>Enter only digits (1), uppercase (A) characters, lowercase (a) characters, or alphanumeric (2aB) characters.</p>	<p>Press a keypad key one or more times (depending what input mode you're in) to enter the characters that is displayed on the keypad key.</p> <p>You can press the abc soft key one or more times to switch among uppercase (ABC soft key), numeric (123 soft key), alphanumeric (2aB soft key), uppercase and lowercase (Abc soft key) and lowercase (abc soft key) input modes.</p> <p>For example, if the input mode is ABC:</p> <ul style="list-style-type: none"> - To enter "A", press  once. - To enter "B", press  twice quickly. - To enter "C", press  three times quickly. - To enter "2Ä/ÉÀÁÂÃÄÅÇ", press  more than three times quickly. <p>Note: When you are in the uppercase (ABC soft key), uppercase and lowercase (Abc soft key) or lowercase (abc soft key) input mode,  is not available.</p>
<p>Enter special characters.</p>	<p>Press the keypad key  or , or press .</p> <p>For  Key:</p> <ul style="list-style-type: none"> - If it is in the uppercase (ABC soft key), uppercase and lowercase (Abc soft key) or lowercase (abc soft key) input mode, it will provide the space character. - If it is in the numeric (123 soft key) or alphanumeric (2aB soft key) input mode, it will only provide the digit 0. <p>For  key:</p> <ul style="list-style-type: none"> - It only provides the pound character #. <p>For  key:</p> <ul style="list-style-type: none"> - If it is in the uppercase (ABC soft key), lowercase (abc soft key), uppercase and

If you want to	Then you can
	<p>lowercase (Abc soft key) or alphanumeric (2aB soft key) input mode, it will provide the following special characters: *.,?!\(-)@/:_+&%=<> £ \$ ¥ € [] {} ~ ^ ` \$ # " .</p> <p>- If it is in the numeric (123 soft key) input mode, it will provide the following special characters: ./:/@[].</p>
Delete text you entered.	Press  or  to position the cursor to the right of the text you want to delete, and then press the Delete soft key to delete one character at a time.

Customizing Your Phone

You can customize your SIP-T23P/G IP phone by personally configuring certain settings, for example, contrast, language and time & date. You can add contacts to the phone's local directory manually or from call history. You can also personalize different ring tones for different callers.

This chapter provides basic operating instructions for customizing your phone. Topics include:

- [General Settings](#)
- [Audio Settings](#)
- [Contact Management](#)
- [Call History Management](#)
- [System Customizations](#)

If you require additional information or assistance with your new phone, contact your system administrator.

General Settings



Backlight

You can configure the backlight to adjust the brightness of the LCD screen. Backlight status on the LCD screen can be configured from the following options:

- **Always On:** Backlight is on permanently.
- **Always Off:** Backlight is off permanently.
- **15s, 30s, 60s, 120s, 300s, 600s or 1800s:** Backlight is turned off when the phone is inactive after the designated time (in seconds).

To configure the backlight via phone user interface:

1. Press **Menu->Settings->Basic Settings->Display->Backlight**.

- Press  or  , or the **Switch** soft key to select the desired time from the **Backlight Time** field.

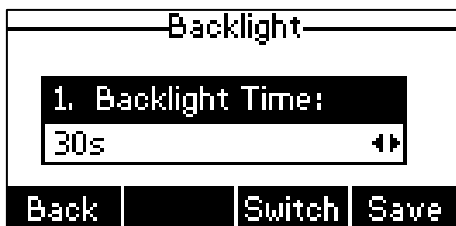



- Press the **Save** soft key to accept the change or the **Back** soft key to cancel.

Backlight is configurable via web user interface at the path **Settings->Preference**.

Contrast

You can configure the LCD screen contrast to a comfortable level. The intensity of contrast ranges from 1 to 10 and the highest intensity is 10.

To configure the contrast via phone user interface:

- Press **Menu->Settings->Basic Settings->Display->Contrast**.
- Press  or  , or the **Switch** soft key to increase or decrease the intensity of contrast.

The default contrast level is "6".

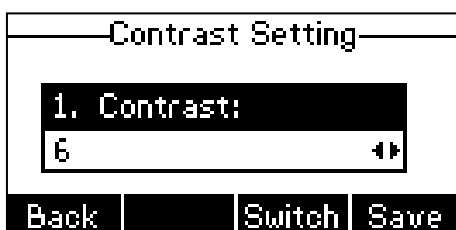

- Press the **Save** soft key to accept the change or the **Back** soft key to cancel.



Contrast is configurable via web user interface at the path **Settings->Preference**.

Language

The default language of the phone user interface is English. If the language of your web browser is not supported by the phone, the web user interface will use English by default. You can change the language for the phone user interface and the web user interface respectively.

To change the language for the phone user interface:

- Press **Menu->Settings->Basic Settings->Language**.

- Press  or  to select the desired language.



- Press the **Save** soft key to accept the change.

Text displayed on the phone user interface will change to the selected language.

To change the language for the web user interface:

- Click on **Settings->Preference**.
- Select the desired language from the pull-down list of **Language**.

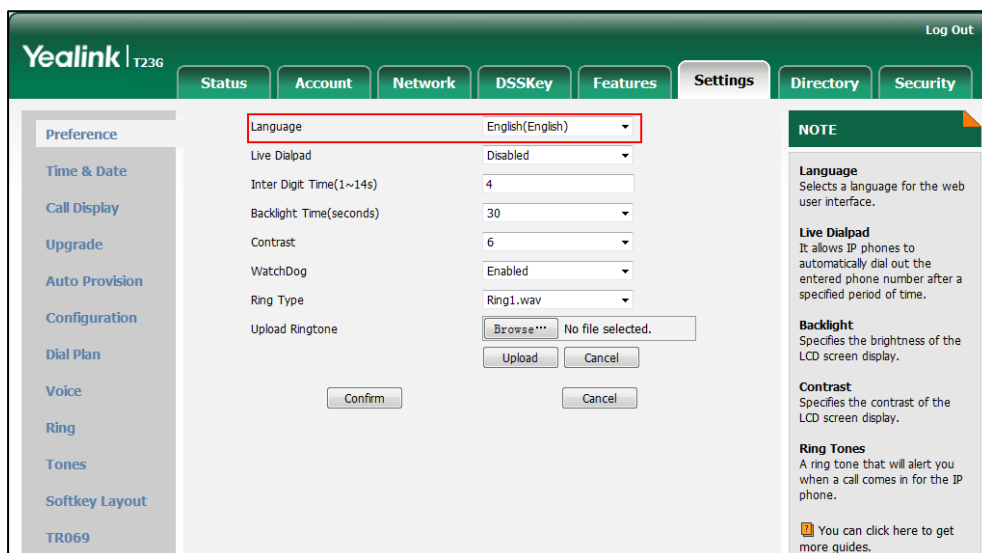



- Click **Confirm** to accept the change.

Text displayed on the web user interface will change to the selected language.

Time & Date

The time and date are displayed on the LCD screen when the phone is idle. You can configure the phone to obtain the time and date from the SNTP server automatically, or configure the time and date manually. If the phone cannot obtain the time and date from the Simple Network Time Protocol (SNTP) server, contact your system administrator for more information.

To configure the SNTP settings via phone user interface:

- Press **Menu->Settings->Basic Settings->Time & Date->SNTP Settings**.
- Press  or , or the **Switch** soft key to select the time zone that applies to your

area from the **Time Zone** field.

The default time zone is "+8".

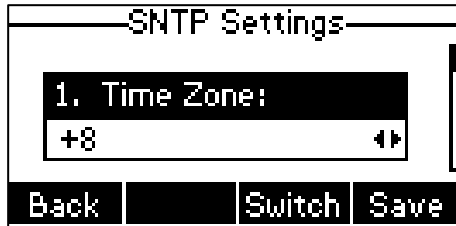

3. Enter the domain name or IP address of SNTP server in the **NTP Server1** and **NTP Server2** field respectively.
4. Press ◀ or ▶, or the **Switch** soft key to select the desired value from the **Daylight Saving** field.
5. Press ◀ or ▶, or the **Switch** soft key to select the desired time zone name from the **Location** field.

This field appears only if **Daylight Saving** field is selected **Automatic**.

The default time zone name is "China(Beijing)".

6. Press the **Save** soft key to accept the change or the **Back** soft key to cancel.

Note

Please refer to [Appendix A - Time Zones](#) for the list of available time zones on the IP phone.

To configure the time and date manually via phone user interface:

1. Press **Menu->Settings->Basic Settings->Time & Date->Manual Settings**.
2. Enter the specific date in the **Date(YMD)** field.
3. Enter the specific time in the **Time(HMS)** field.

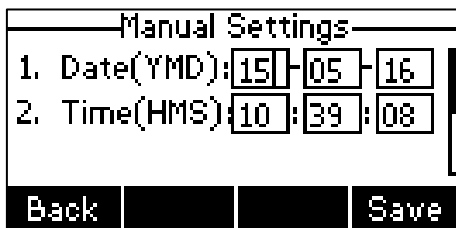

4. Press the **Save** soft key to accept the change.
The date and time displayed on the LCD screen will change accordingly.

To configure the time and date format via phone user interface:

1. Press **Menu->Settings->Basic Settings->Time & Date->Time & Date Format**.

2. Press ◀ or ▶, or the **Switch** soft key to select the desired time format (**12 Hour** or **24 Hour**) from the **Time Format** field.

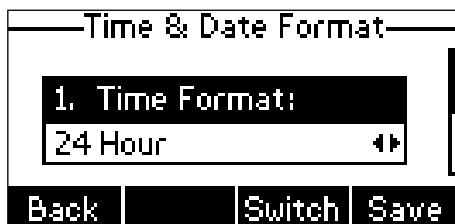

3. Press ◀ or ▶, or the **Switch** soft key to select the desired date format from the **Date Format** field.
4. Press the **Save** soft key to accept the change or the **Back** soft key to cancel.

There are 7 available date formats. For example, for the date format “WWW DD MMM”, “WWW” represents the abbreviation of the weekday, “DD” represents the two-digit day, and “MMM” represents the first three letters of the month.

The date formats available:

Date Format	Example (2015-05-16)
WWW MMM DD	Sat May 16
DD-MMM-YY	16-May-15
YYYY-MM-DD	2015-05-16
DD/MM/YYYY	16/05/2015
MM/DD/YY	05/16/15
DD MMM YYYY	16 May 2015
WWW DD MMM	Sat 16 May

Time and date are configurable via web user interface at the path **Settings->Time & Date**.

Administrator Password

The Advanced Settings option is only accessible to the administrator. The default administrator password is “admin”. For security reasons, you should change the default administrator password as soon as possible.

To change the administrator password via phone user interface:

1. Press **Menu->Settings->Advanced Settings** (default password: admin) ->**Set Password**.

2. Enter the current password in the **Current PWD** field.

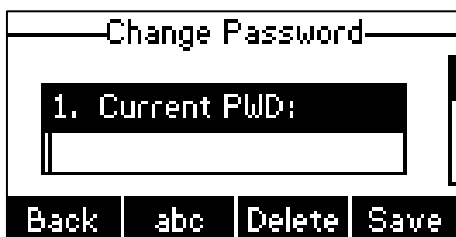

3. Enter the new password in the **New PWD** field.
4. Re-enter the new password in the **Confirm PWD** field.
5. Press the **Save** soft key to accept the change or the **Back** soft key to cancel.

Administrator password is configurable via web user interface at the path **Security->Password**.

Key as Send

You can set the “#” key or “*” key to perform as a send key while dialing.

To configure key as send via phone user interface:

1. Press **Menu->Features->Key as send**.
2. Press ◀ or ▶, or the **Switch** soft key to select # or * from the **Key as send** field, or select **Disabled** to disable this feature.

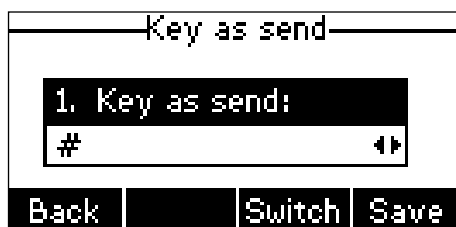

3. Press the **Save** soft key to accept the change or the **Back** soft key to cancel.

Key as send is configurable via web user interface at the path **Features->General Information**.

Phone Lock

You can lock your phone temporarily when you are not using it. This feature helps to protect your phone from unauthorized use.

Phone lock consists of the following:

- Menu Key:** The **Menu** soft key is locked. You cannot access the menu of the phone until unlocked.
- Function Keys:** The function keys are locked. You cannot use the MESSAGE, RD,



TRAN, OK, X, navigation keys and soft keys until unlocked.

- All Keys:** All keys are locked except the Volume key, digit keys, # key, * key and Speakerphone key. You are only allowed to dial emergency numbers, reject incoming calls by pressing the X key or the **Reject** soft key, answer incoming calls by lifting the handset, pressing the Speakerphone key, the HEADSET key, the OK key, or the **Answer** soft key, mute an active call by pressing the X key, and end the call by hanging up the handset, pressing the Speakerphone key or the **EndCall** soft key.



Note

The emergency number setting, if desired, must be set before lock activation. For more information, refer to [Emergency Number](#) on page 83.

To activate the phone lock via phone user interface:

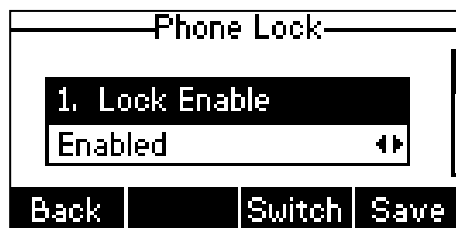
1. Press **Menu->Settings->Advanced Settings** (default password: admin) ->**Phone Lock**.
2. Press  or , or the **Switch** soft key to select **Enabled** from the **Lock Enable** field.



3. Press  or , or the **Switch** soft key to select the desired type from the **Lock Type** field.

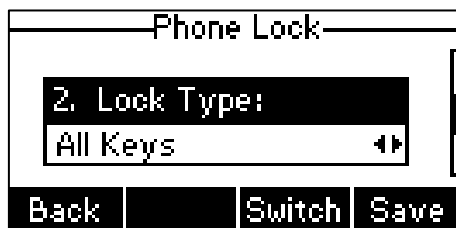

4. (Optional.) Enter the desired interval of automatic phone lock in the **Lock Time Out** field.

The default timeout is 0. It means the phone will not be automatically locked. You need to long press  to lock it immediately when the phone is idle.

If it is set to other values except 0 (e.g., 5), the phone will be locked when the phone is inactive in idle screen for the designated time (in seconds).

5. Press the **Save** soft key to accept the change.

When the phone is locked, the LCD screen prompts "Phone locked." and displays

the icon .



To unlock the phone, you must know the phone unlock PIN. The default phone unlock PIN is "123".

To change the phone unlock PIN via phone user interface:

1. Press **Menu->Settings->Basic Settings->Change PIN**.
2. Enter the desired value in the **Current PIN**, **New PIN** and **Confirm PIN** field respectively.





3. Press the **Save** soft key to accept the change or the **Back** soft key to cancel.

Note The unlock PIN length must be within 15 digits.

To unlock the phone via phone user interface:

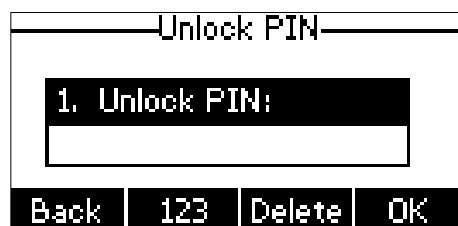
1. Press any locked key, the LCD screen prompts "Unlock PIN".





2. Enter the PIN in the **Unlock PIN** field.
3. Press the **OK** soft key to unlock the phone.
The  icon disappears from the LCD screen.

You can long press  or wait for a period of time (if configured) to lock the phone again.

Note

You can also unlock the phone by administrator password. When you enter the administrator password to unlock the phone, the phone will turn to the Change PIN screen.

To deactivate the phone lock via phone user interface:

1. Press **Menu->Settings->Advanced Settings** (default password: admin) ->**Phone Lock**.
2. Press  or , or the **Switch** soft key to select **Disabled** from **Lock Enable** field.

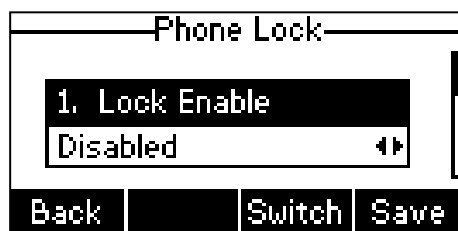

3. Press the **Save** soft key to accept the change.

Phone lock is configurable via web user interface at the path **Features->Phone Lock**.

Audio Settings

Volume

You can press the Volume key to adjust the ringer volume when the phone is idle. You can also press the Volume key to adjust the receiver volume of currently engaged audio devices (handset, speakerphone or headset) when the phone is in use.

To adjust the volume when the phone is idle:

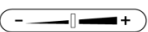
1. Press  to adjust the ringer volume.

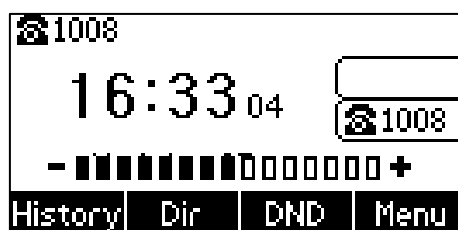

Note

If the ringer volume is adjusted to minimum, the  icon will appear on the LCD screen.

To adjust the volume when the phone is during a call:



1. Press  to adjust the volume of currently engaged audio device (handset, speakerphone or headset).



Ring Tones

Ring tones are used to indicate incoming calls. You can select different ring tones to distinguish different accounts registered on your phone, or to distinguish your phone from your neighbor's.

To select a ring tone for the phone via phone user interface:

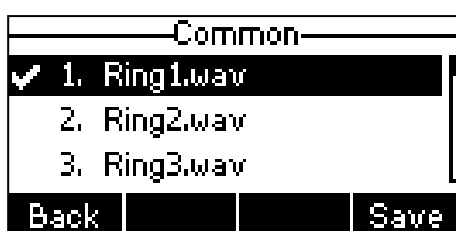

1. Press **Menu->Settings->Basic Settings->Sound->Ring Tones->Common**.
2. Press  or  to select the desired ring tone.





3. Press the **Save** soft key to accept the change or the **Back** soft key to cancel.

A ring tone for the phone is configurable via web user interface at the path **Settings->Preference->Ring Type**.

To select a ring tone for the account via phone user interface:

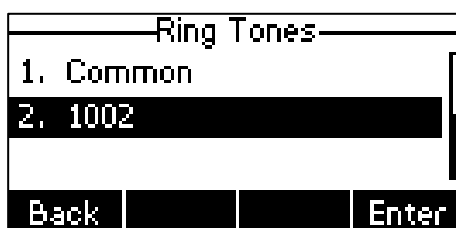
1. Press **Menu->Settings->Basic Settings->Sound->Ring Tones**.
2. Press  or  to select the desired account and then press the **Enter** soft key.



3. Press  or  to select the desired ring tone.

If **Common** is selected, this account will use the ring tone selected for the phone.

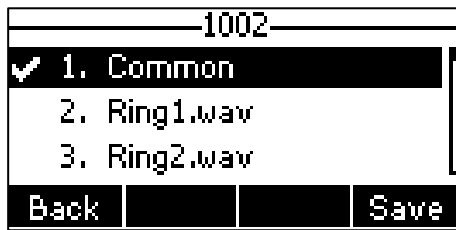

4. Press the **Save** soft key to accept the change or the **Back** soft key to cancel.

A ring tone for the account is configurable via web user interface at the path **Account->Basic->Ring Type**.

To upload a custom ring tone for your phone via web user interface:

1. Click on **Settings->Preference**.
2. In the **Upload Ringtone** field, click **Browse** to locate a ring tone (the file format must be *.wav) file from your local system.

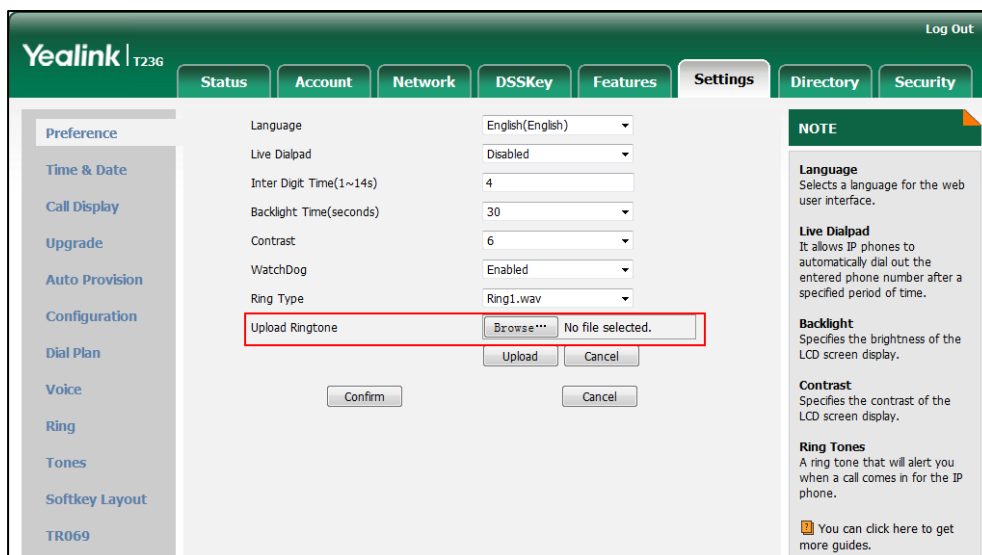

3. Click **Upload** to upload the file.

Note

The priority of ring tone for an incoming call on the phone is as follows:
 Contact ring tone (refer to [Adding Contacts](#)) >Group ring tone (refer to [Adding Groups](#)) >Account ring tone >Phone ring tone.

Both single custom ring tone file and total custom ring tone files must be within 100KB.

Uploading custom ring tones for your phone is configurable via web user interface only.

Contact Management





This section provides the operating instructions for managing contacts. Topics include:

- [Directory](#)
- [Local Directory](#)
- [Blacklist](#)
- [Remote Phone Book](#)

Directory

Directory provides easy access to frequently used lists. The lists may contain Local Directory, History, Remote Phone Book and LDAP.

To configure the directory via web user interface:

1. Click on **Directory->Setting**.
2. In the **Directory** block, select the desired list from the **Disabled** column and then click  .
The selected list appears in the **Enabled** column.
3. Repeat the step 2 to add more lists to the **Enabled** column.
4. To remove a list from the **Enabled** column, select the desired list and then click  .
5. To adjust the display order of enabled lists, select the desired list and then click  or  .

The LCD screen displays the list(s) in the adjusted order.

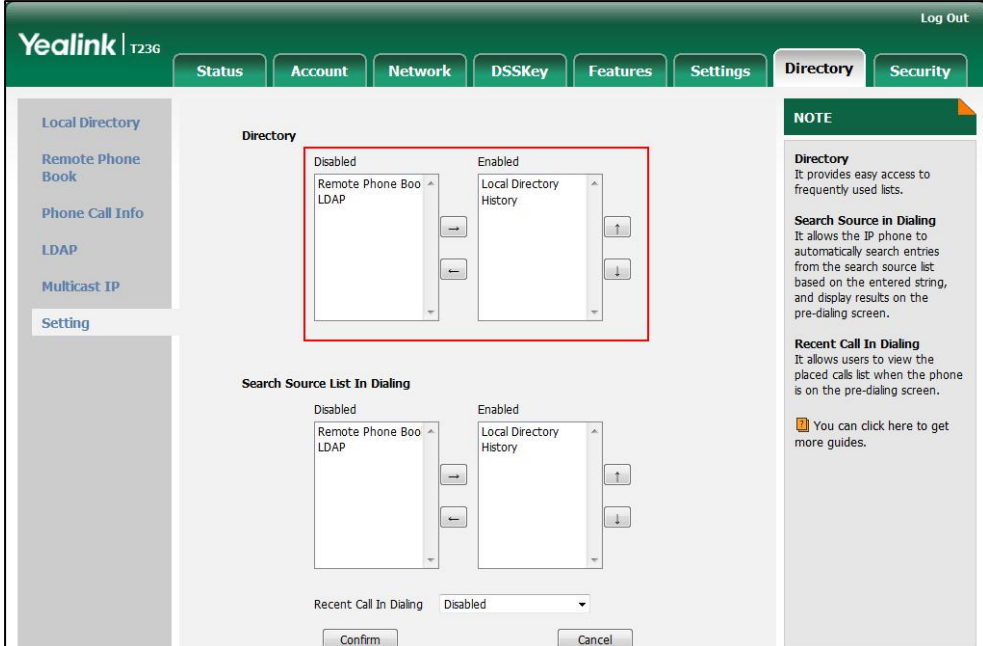

Yealink T236 Log Out

Status Account Network DSSKey Features Settings **Directory** Security

Local Directory
Remote Phone Book
Phone Call Info
LDAP
Multicast IP
Setting

Directory

Disabled	Enabled
Remote Phone Book LDAP	Local Directory History

Search Source List In Dialing

Disabled	Enabled
Remote Phone Book LDAP	Local Directory History

Recent Call In Dialing: Disabled

Confirm Cancel

NOTE

Directory
It provides easy access to frequently used lists.

Search Source in Dialing
It allows the IP phone to automatically search entries from the search source list based on the entered string, and display results on the pre-dialing screen.

Recent Call In Dialing
It allows users to view the placed calls list when the phone is on the pre-dialing screen.

You can click here to get more guides.

- Click **Confirm** to accept the change.

Note Directory is configurable via web user interface only.

To check the directory via phone user interface:

- Press the **Dir** soft key when the phone is idle.

The LCD screen displays the enabled list(s) in the directory.



If there is only one list in the directory, press the **Dir** soft key to enter this list directly.

Note If the remote phone book and LDAP are not configured in advance, you cannot see remote phone book and LDAP lists on the phone user interface. For more information on remote phone book, refer to [Remote Phone Book](#) on page 59. For more information on the LDAP, refer to [Yealink_SIP-T2_Series_T19\(P\) E2_T4_Series_CP860_IP_Phones_Administrator_Guide](#).

Local Directory

The built-in phone directory can store the names and phone numbers of your contacts. You can store up to 1000 contacts and 48 groups in your phone's local directory. You can add new groups and contacts, edit, delete or search for a contact, or simply dial a contact number from the local directory.

Adding Groups

To add a group to the local directory:

- Press the **Dir** soft key.

The IP phone enters the local directory directly as there is only Local Directory enabled in the directory by default.



If Local Directory is removed from the directory (refer to [Directory](#) on page 46), press **Menu->Directory->Local Directory** to enter the local directory.

2. Press the **AddGr** soft key.
3. Enter the desired group name in the **Name** field.
4. Press **◀** or **▶** , or the **Switch** soft key to select the desired group ring tone from the **Ring** field.

If **Auto** is selected, this group will use the ring tone according to the priority: Contact ring tone (refer to [Adding Contacts](#)) >Account ring tone (refer to [Ring Tones](#)) >Phone ring tone (refer to [Ring Tones](#)). If a specific ring tone is selected, this group will use the ring tone according to the priority: Contact ring tone (refer to [Adding Contacts](#)) >Group ring tone.



5. Press the **Add** soft key to accept the change or the **Back** soft key to cancel.
You can also edit or delete any newly added contact groups.

Editing Groups

To edit a group in the local directory:

1. Press the **Dir** soft key.

The IP phone enters the local directory directly as there is only Local Directory enabled in the directory by default.





If Local Directory is removed from the directory (refer to [Directory](#) on page 46), press **Menu->Directory->Local Directory** to enter the local directory.

2. Select the desired contact group.

3. Press the **Option** soft key, and then select **Detail**.



4. Press  or  to scroll through the group information and then edit.

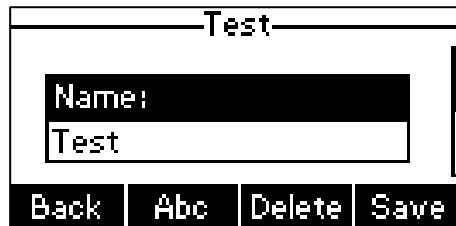

5. Press the **Save** soft key to accept change or the **Back** soft key to cancel.

Deleting Groups

To delete a group from the local directory:

1. Press the **Dir** soft key.

The IP phone enters the local directory directly as there is only Local Directory enabled in the directory by default.



If Local Directory is removed from the directory (refer to [Directory](#) on page 46), press **Menu->Directory->Local Directory** to enter the local directory.

2. Select the desired contact group.
3. Press the **Option** soft key, and then select **Delete**.

The LCD screen prompts the following warning:

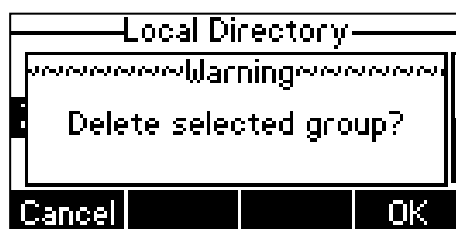

- Press the **OK** soft key to confirm the deletion or the **Cancel** soft key to cancel.
You can also delete all groups by pressing the **Option** soft key and then select **Delete All**.

Adding Contacts

You can add contacts to the local directory in the following ways:

- Manually
- From call history
- From a remote phone book

Adding Contacts Manually

To add a contact to the local directory manually:

- Press the **Dir** soft key.
The IP phone enters the local directory directly as there is only Local Directory enabled in the directory by default.







If Local Directory is removed from the directory (refer to [Directory](#) on page 46), press **Menu->Directory->Local Directory** to enter the local directory.

- Select the desired contact group and then press the **Enter** soft key.
If the contact is not in any group, select **All Contacts** and then press the **Enter** soft key.
- Press the **Add** soft key.
- Enter the name and the office, mobile or other numbers in the corresponding fields.



- Press **◀** or **▶**, or the **Switch** soft key to select the desired account from the **Account** field.
If **Auto** is selected, the phone will use the default account when placing calls to the contact from the local directory.



6. Press  or , or the **Switch** soft key to select the desired ring tone from the **Ring** field.
If **Auto** is selected, this contact will use the ring tone according to the priority: Group ring tone (refer to [Adding Groups](#)) >Account ring tone (refer to [Ring Tones](#))>Phone ring tone (refer to [Ring Tones](#)).
7. Press  or , or the **Switch** soft key to select the desired group from the **Group** field.
8. Press the **Add** soft key to accept the change or the **Back** soft key to cancel.

Note

If the contact has existed in the directory, the LCD screen will prompt "Contact name existed!".

Adding Contacts from Call History

To add a contact to the local directory from the call history:



1. Press the **History** soft key.
2. Press  or  to highlight the desired entry.
3. Press the **Option** soft key, and then select **Add to Contacts**.



4. Press the **OK** soft key, and then edit the contact name.
5. Press the **Save** soft key to accept the change.
The entry is successfully saved to the local directory.

Adding Contacts from Remote Phone Book

To add a contact to the local directory from remote phone book:

1. Press **Menu->Directory->Remote Phone Book**.
If Remote Phone Book is added to the directory (refer to [Directory](#) on page 46), press **Dir->Remote Phone Book** to enter the remote phone book.
2. Select the desired remote group and then press the **Enter** soft key.
3. Press  or  to highlight the desired entry.
4. Press the **Option** soft key, and then select **Add to Contacts**.
5. Press the **Save** soft key to save the contact in the local directory.
If the contact has already existed in the local directory, the LCD screen will prompt "Contact name existed, overwrite?". Press the **OK** soft key to overwrite the original

contact in local directory or the **Cancel** soft key to cancel.

For more information on remote phone book operating, refer to [Remote Phone Book](#) on page 59.

Editing Contacts

To edit a contact in the local directory:

1. Press the **Dir** soft key.

The IP phone enters the local directory directly as there is only Local Directory enabled in the directory by default.



If Local Directory is removed from the directory (refer to [Directory](#) on page 46), press **Menu->Directory->Local Directory** to enter the local directory.

2. Select the desired contact group and then press the **Enter** soft key.

If the contact is not in any group, select **All Contacts** and then press the **Enter** soft key.

3. Press \uparrow or \downarrow to highlight the desired contact.
4. Press the **Option** soft key, and then select **Detail**.
5. Press \uparrow or \downarrow to highlight the contact information and then edit.



6. Press the **Save** soft key to accept change or the **Back** soft key to cancel.

Deleting Contacts

To delete a contact from the local directory:

1. Press the **Dir** soft key.

The IP phone enters the local directory directly as there is only Local Directory enabled in the directory by default.



If Local Directory is removed from the directory (refer to [Directory](#) on page 46), press **Menu->Directory->Local Directory** to enter the local directory.

2. Select the desired contact group and then press the **Enter** soft key.
If the contact is not in any group, select **All Contacts** and then press the **Enter** soft key.
3. Press \uparrow or \downarrow to highlight the desired contact.
4. Press the **Option** soft key, and then select **Delete**.

The LCD screen prompts the following warning:

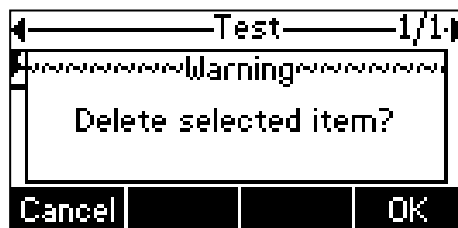

5. Press the **OK** soft key to confirm the deletion or the **Cancel** soft key to cancel.

You can also delete all contacts by pressing the **Option** soft key, and then select **Delete All**.

Placing Calls to Contacts





To place a call to a contact from the local directory:

1. Press the **Dir** soft key.

The IP phone enters the local directory directly as there is only Local Directory enabled in the directory by default.



If Local Directory is removed from the directory (refer to [Directory](#) on page 46),

- press **Menu->Directory->Local Directory** to enter the local directory.
2. Select the desired contact group and then press the **Enter** soft key.
If the contact is not in any group, select **All Contacts** and then press the **Enter** soft key.
 3. Press  or  to highlight the desired contact.
 4. Do one of the following:
 - If only one number of the contact is stored in the local directory, press the **Send** soft key to dial out the number.
 - If multiple numbers of the contact are stored in the local directory, press the **Send** soft key to display a list of numbers.
Press  or  to highlight the desired number.
Press the **Send** soft key to dial out the number.

Searching for Contacts

To search for a contact in the local directory:

1. Press the **Dir** soft key.
The IP phone enters the local directory directly as there is only Local Directory enabled in the directory by default.



If Local Directory is removed from the directory (refer to [Directory](#) on page 46), press **Menu->Directory->Local Directory** to enter the local directory.

2. Press the **Search** soft key.
3. Enter a few continuous characters of the contact name or continuous numbers of the contact number (office, mobile or other number) using the keypad.







The contacts whose name or phone number matches the characters entered will appear on the LCD screen. You can dial from the result list.

Search Source List in Dialing

You can search for a contact from the desired lists when the phone is on the dialing screen. The lists can be Local Directory, History, Remote Phone Book and LDAP.

To configure search source list in dialing via web user interface:

1. Click on **Directory->Setting**.
2. In the **Search Source List In Dialing** block, select the desired list from the **Disabled** column and then click  .
The selected list appears in the **Enabled** column.
3. Repeat the step 2 to add more lists to the **Enabled** column.
4. To remove a list from the **Enabled** column, select the desired list and then click  .
5. To adjust the display order of search results, select the desired list and then click  or  .

The LCD screen will display search results in the adjusted order.

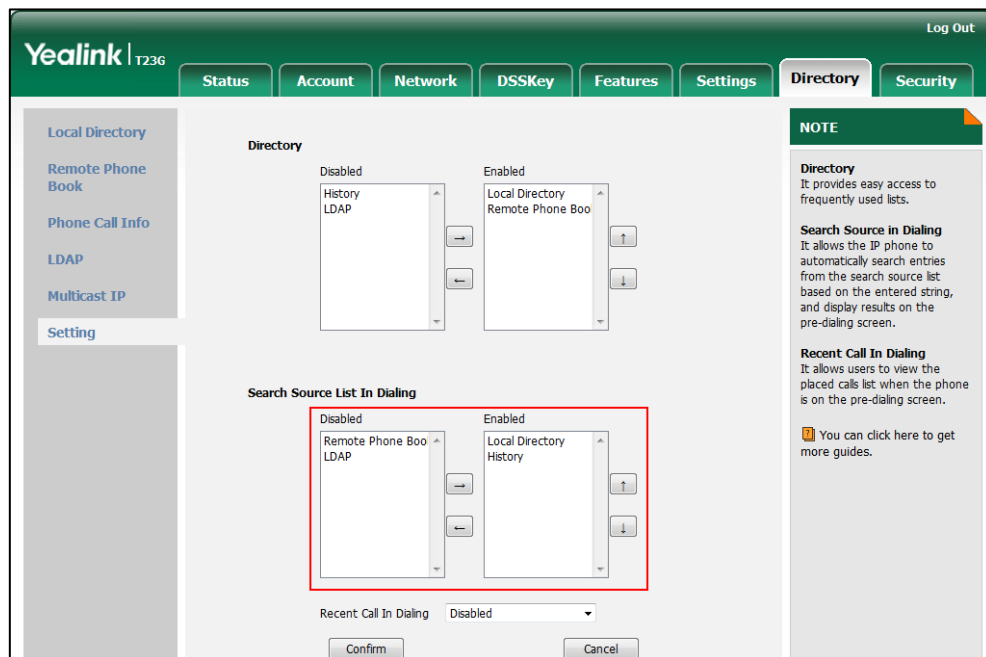

The screenshot shows the Yealink T236 web interface. The 'Directory' tab is selected, and the 'Setting' sub-tab is active. The 'Search Source List In Dialing' section is highlighted with a red box. It contains two columns: 'Disabled' and 'Enabled'. In the 'Disabled' column, 'Remote Phone Book' and 'LDAP' are listed. In the 'Enabled' column, 'Local Directory' and 'History' are listed. Below the columns is a 'Recent Call In Dialing' dropdown set to 'Disabled'. There are 'Confirm' and 'Cancel' buttons at the bottom.



6. Click **Confirm** to accept the change.

Note

Search source list in dialing is configurable via web user interface only.

To search for a contact in the enabled search source lists:

1. Pick up the handset, press the Speakerphone key or press the line key.
2. Enter a few continuous characters of the entry's name or continuous numbers of the entry's phone number (office, mobile or other number) using the keypad.

The entries in the enabled search source lists whose name or phone number matches the characters entered will appear on the LCD screen. You can press  or  to scroll to the desired entry, and then place a call to the entry.

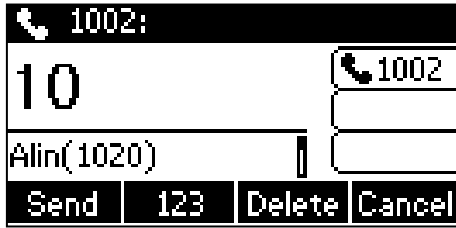

Importing/Exporting Contact Lists

You can manage your phone's local directory via phone user interface or web user interface. But you can only import or export the contact list via web user interface.

To import an XML file of contact list via web user interface:

1. Click on **Directory->Local Directory**.
2. Click **Browse** to locate a contact list file (the file format must be *.xml) from your local system.

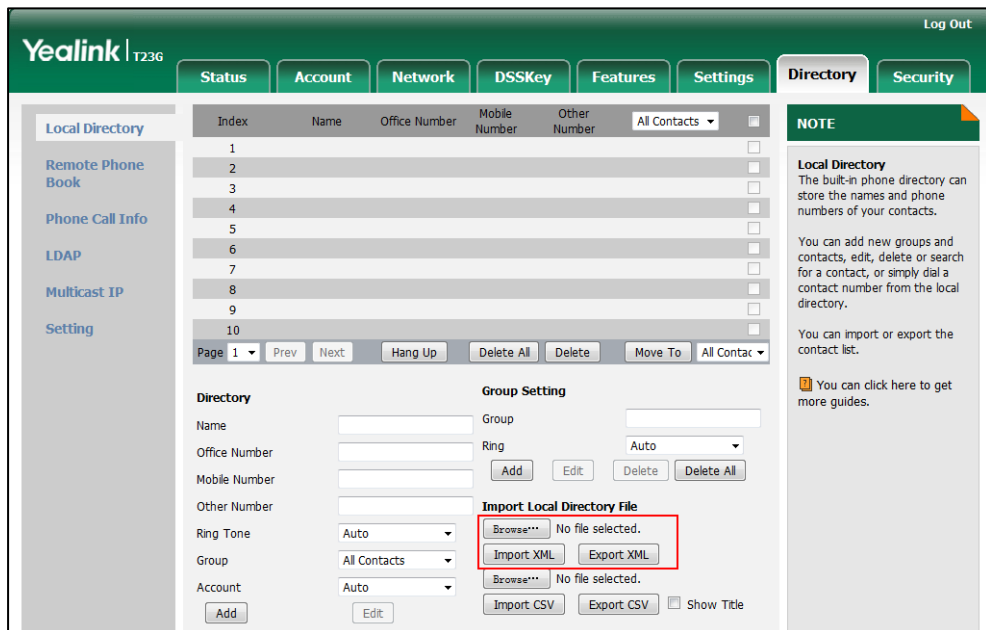

3. Click **Import XML** to import the contact list.
The web user interface prompts "The original contact will be covered, continue?".
4. Click **OK** to complete importing the contact list.

To import a CSV file of contact list via web user interface:

1. Click on **Directory->Local Directory**.
2. Click **Browse** to locate a contact list file (file format must be *.csv) from your local

system.

3. (Optional.) Check the **Show Title** checkbox.
It will prevent importing the title of the contact information which is located in the first line of the CSV file.
4. Click **Import CSV** to import the contact list.
5. (Optional.) Mark the **On** radio box in the **Delete Old Contacts** field.
It will delete all existing contacts while importing the contact list.
6. Select the contact information you want to import into the local directory from the pull-down list of **Index**.
At least one item should be selected to be imported into the local directory.

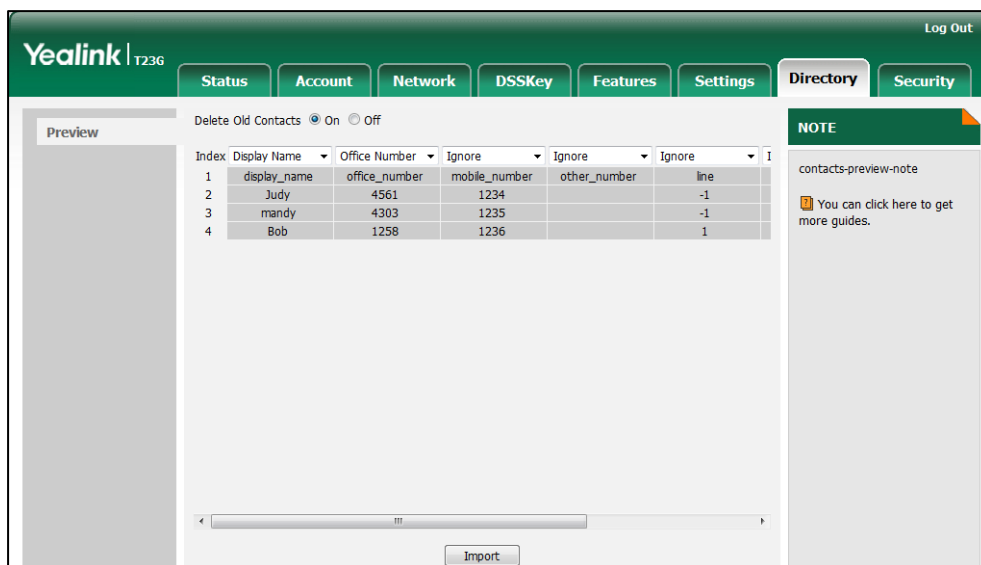

7. Click **Import** to complete importing the contact list.

To export a contact list via web user interface:

1. Click on **Directory->Local Directory**.
2. Click **Export XML** (or **Export CSV**).
3. Click **Save** to save the contact list to your local system.

Note Importing/exporting contact lists is available via web user interface only.



Blacklist

The built-in phone directory can store names and phone numbers for a blacklist. You can store up to 30 contacts, add, edit, delete or search for a contact in the blacklist directory, and even call a contact from the blacklist directory. Incoming calls from blacklist directory contacts will be rejected automatically.

To add a contact to the blacklist directory manually:

1. Press **Menu->Directory->Blacklist**.
2. Press the **Add** soft key.
3. Enter the name and the office, mobile or other numbers in the corresponding fields.



4. Press  or , or the **Switch** soft key to select the desired account from the **Account** field.

If **Auto** is selected, the phone will use the default account when placing calls to the contact from the blacklist directory.

5. Press the **Add** soft key to accept the change or the **Back** soft key to cancel.



To add a contact to the blacklist directory from the local directory:

1. Press the **Dir** soft key.

The IP phone enters the local directory directly as there is only Local Directory enabled in the directory by default.



If Local Directory is removed from the directory (refer to [Directory](#) on page 46), press **Menu->Directory->Local Directory** to enter the local directory.

2. Select the desired contact group and then press the **Enter** soft key.
If the contact is not in any group, select **All Contacts** and then press the **Enter** soft key.
3. Press  or  to highlight the desired contact.
4. Press the **Option** soft key and then select **Add to Blacklist**.

The LCD screen prompts the following warning:



5. Press the **OK** soft key to accept the change.

For operating instructions on editing, deleting, placing calls to and/or searching for contacts in the blacklist directory, refer to the operating instructions of [Local Directory](#) on page 47.

Remote Phone Book

You can add new contacts to the local directory, search for a contact, or simply dial a contact number from the remote phone book.

You can configure your new phone to access up to 5 remote phone books. For the access URL of the remote phone book, contact your system administrator.

Configuring an Access URL

To configure an access URL for a remote phone book via web user interface:

1. Click on **Directory->Remote Phone Book**.
2. Enter the access URL in the **Remote URL** field.
3. Enter the name in the **Display Name** field.

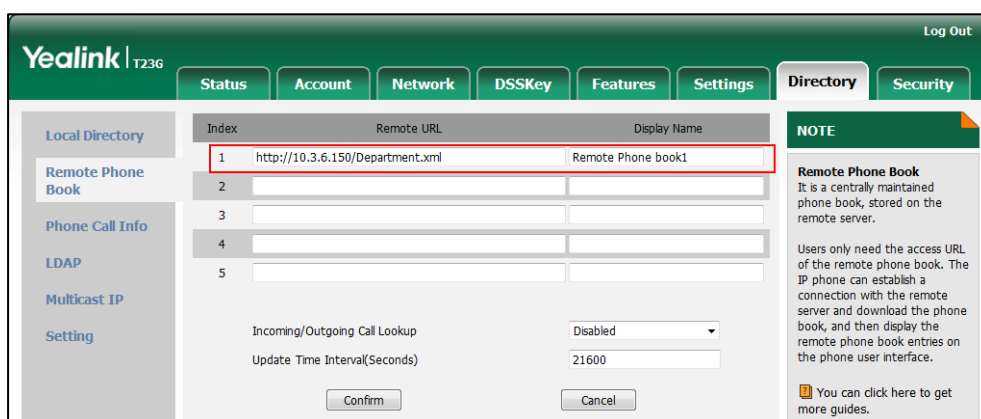

4. Click **Confirm** to accept the change.



Note An access URL for a remote phone book is configurable via web user interface only.

Accessing the Remote Phone Book

To access your remote phone book via phone user interface:

1. Press **Menu->Directory->Remote Phone Book**.

If Remote Phone Book is added to the directory (refer to [Directory](#) on page 46), press **Dir->Remote Phone Book** to enter the remote phone book.

2. Press  or  to select the desired remote group, and then press the **Enter** soft key.

The phone then connects to the remote phone book and proceeds to load it. The contacts in the remote phone book are displayed on the LCD screen.

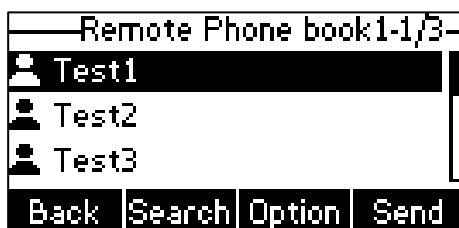

3. Press the **Back** soft key to back to the previous screen.

Placing Calls to Contacts

To place a call from the remote phone book:

1. Press **Menu->Directory->Remote Phone Book**.

If Remote Phone Book is added to the directory (refer to [Directory](#) on page 46), press **Dir->Remote Phone Book** to enter the remote phone book.

2. Select the desired remote group, and then press the **Enter** soft key to load the remote phone book.
3. Select the desired contact in the remote phone book.
4. Press the **Send** soft key.

Searching for Contacts

To search for a contact in the remote phone book:

1. Press **Menu->Directory->Remote Phone Book**.

If Remote Phone Book is added to the directory (refer to [Directory](#) on page 46), press **Dir->Remote Phone Book** to enter the remote phone book.

2. Select the desired remote group, and then press the **Enter** soft key to load the remote phone book.
3. Press the **Search** soft key.
4. Press the **Abc** soft key to change the input mode. And then enter a few continuous characters of the contact name or continuous numbers of the contact number using

the keypad.

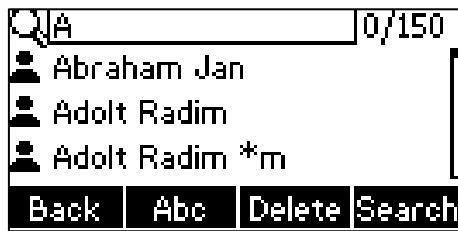

The contacts whose name or phone number matches the characters entered will appear on the LCD screen. You can place a call from the result list.

Incoming/Outgoing Call Lookup

You can enable the phone to present the caller/callee identity stored in the remote phone book when receiving/placing a call.

To configure incoming/outgoing call lookup and update time interval via web user interface:

1. Click on **Directory->Remote Phone Book**.
2. Select **Enabled** from the pull-down list of **Incoming/Outgoing Call Lookup**.
3. Enter the desired refresh period in the **Update Time Interval(Seconds)** field.

The default value is 21600.

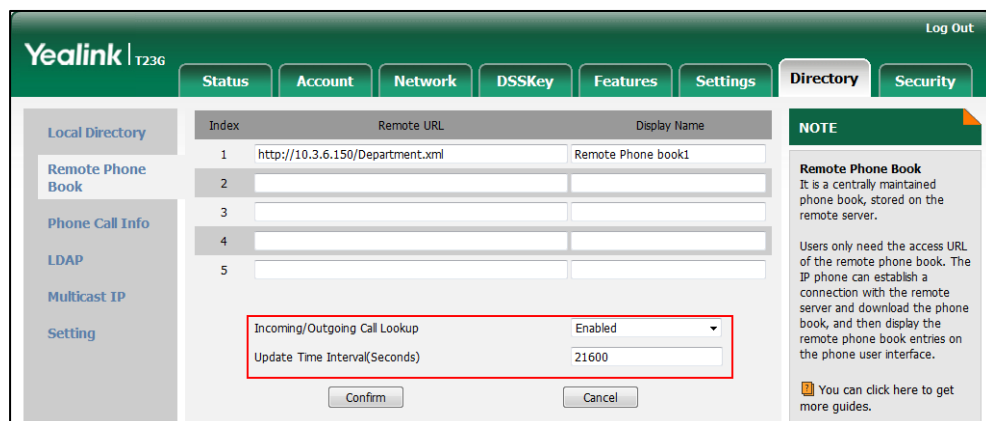

4. Click **Confirm** to accept the change.

Call History Management

The SIP-T23P/G IP phone maintains call history lists of Placed calls, Received calls, Missed calls and Forwarded calls. Each call history list supports up to 100 entries. You can view call history, place a call, add a contact or delete an entry from the call history list.

History record feature is enabled by default. If you don't want to save the call history,

you can disable the feature.

To disable history record via phone user interface:

1. Press **Menu->Features->History Setting**.
2. Press ◀ or ▶, or the **Switch** soft key to select **Disabled** from the **History Record** field.



3. Press the **Save** soft key to accept the change or the **Back** soft key to cancel.

To view the call history:

1. Press the **History** soft key.
The LCD screen displays all call records.
2. Press ◀ or ▶ to switch among **All Calls, Placed Calls, Received Calls, Missed Calls** and **Forwarded Calls**.
3. Press ▲ or ▼ to select the desired entry.
4. Press the **Option** soft key, and then select **Detail**.
The detailed information of the entry appears on the LCD screen.

To place a call from the call history list:





1. Press the **History** soft key.
2. Press ◀ or ▶ to switch among **All Calls, Placed Calls, Received Calls, Missed Calls** and **Forwarded Calls**.
3. Press ▲ or ▼ to select the desired entry.
4. Press the **Send** soft key.

To add a contact to the local directory (or blacklist directory) from the call history list:



1. Press the **History** soft key.
2. Press ◀ or ▶ to switch among **All Calls, Placed Calls, Received Calls, Missed Calls** and **Forwarded Calls**.
3. Press ▲ or ▼ to select the desired entry.
4. Press the **Option** soft key, and then select **Add to Contacts** (or **Add to Blacklist**).
5. Enter the desired values in the corresponding fields.
6. Press the **Save** soft key.

For more information, refer to [Contact Management](#) on page 46.

To delete an entry from the call history list:

1. Press the **History** soft key.
2. Press  or  to switch among **All Calls**, **Placed Calls**, **Received Calls**, **Missed Calls** and **Forwarded Calls**.
3. Press  or  to select the desired entry.
4. Press the **Delete** soft key.

To delete all entries from the call history list:

1. Press the **History** soft key.
2. Press  or  to switch among **All Calls**, **Placed Calls**, **Received Calls**, **Missed Calls** and **Forwarded Calls**.
3. Press the **Option** soft key, and then select **Delete All**.
4. Press the **OK** soft key.

The LCD screen prompts "Delete all the call records?".

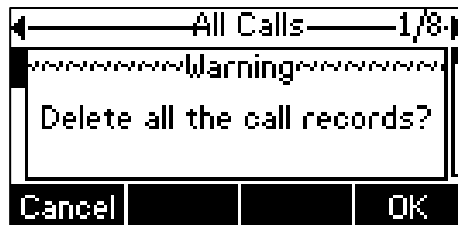

5. Press the **OK** soft key to confirm the deletion or the **Cancel** soft key to cancel.

System Customizations

Logo Customization

You can upload your custom logo which will be shown on the idle screen.

To upload a custom logo via web user interface:

1. Click on **Features->General Information**.
2. Select **Custom logo** from the pull-down list of **Use Logo**.

- Click **Browse** to locate the logo file from your local system.

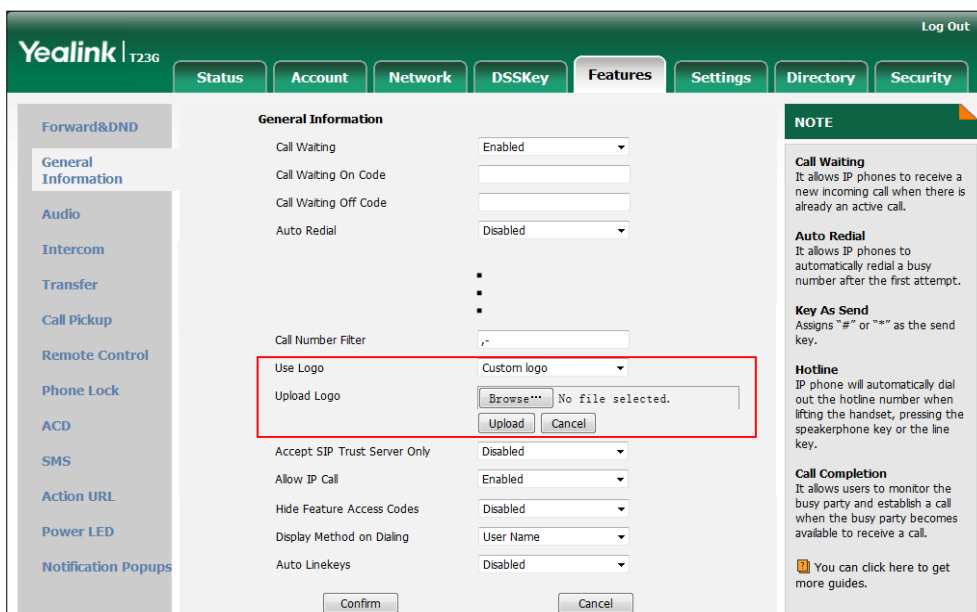

- Click **Upload** to upload the file.

Note **Delete** item will appear after you upload a custom logo, you can click **Delete** to delete the custom logo.

The logo file format must be *.doh, contact your system administrator for more information.

Logo customization is configurable via web user interface only.

Headset Use

If you want to use a headset, physically connect your headset and activate the headset mode for use. For more information on physically connecting a headset, refer to [Phone Installation](#) on page 23.

Headset Mode Activation/Deactivation

To activate the headset mode:

- Press  on the phone.
The headset icon on the idle screen indicates that the headset mode is activated. Press the line key or the **Answer** soft key to answer an incoming call. The call will be connected to your headset automatically.
Enter the desired number and then press the **Send** soft key, the phone will then place a call using the headset automatically. For more information on using the headset to place a call, refer to [Placing Calls](#) on page 88.

To deactivate the headset mode:

1. Press  again on the phone.
The headset icon disappears from the idle screen indicates the headset mode is deactivated.

Headset Prior

You can use headset in priority when headset prior feature is enabled. This feature is especially useful for permanent or full-time headset users.

To enable headset prior via web user interface:

1. Click on **Features->General Information**.
2. Select **Enabled** from the pull-down list of **Headset Prior**.

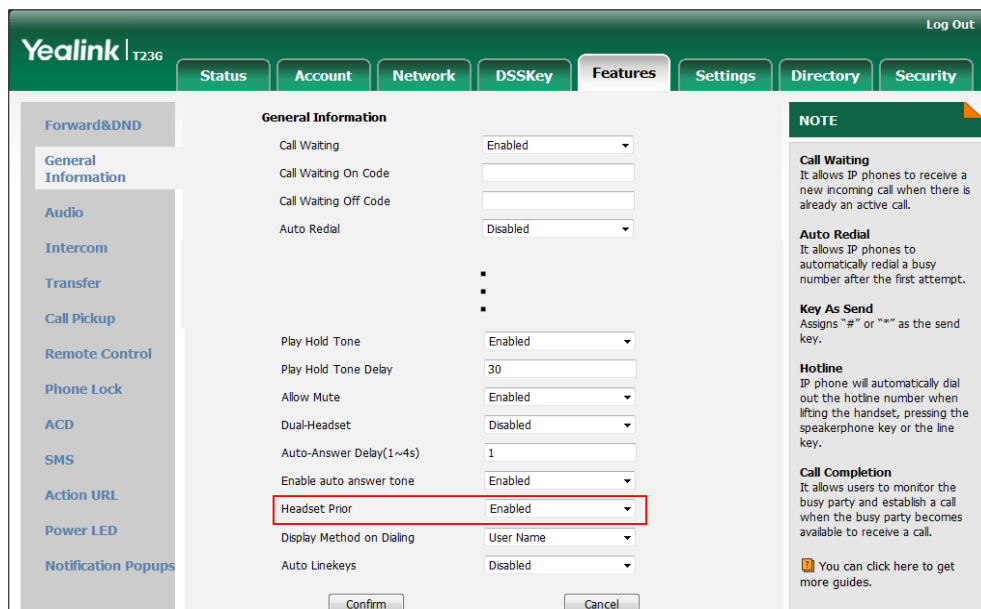

3. Click **Confirm** to accept the change.

To use headset prior feature, you should activate the headset mode in advance:

1. Physically connect the headset.
2. Press  to activate the headset mode.

Note If headset prior is enabled, the headset mode will not be deactivated until you press the **HEADSET** key again.
If headset prior is disabled, the headset mode can be deactivated by pressing the Speakerphone key or the **HEADSET** key.
Headset prior is configurable via web user interface only.

Dual Headset

You can use two headsets when enabling dual headset. To use this feature, you must physically connect headsets to the headset jack and handset jack respectively. Once the phone connects to a call, the headset connected to the headset jack will have full-duplex capabilities, while the one connected to the handset jack will only be able to listen.

To enable dual headset via web user interface:

1. Click on **Features->General Information**.
2. Select **Enabled** from the pull-down list of **Dual-Headset**.

The screenshot shows the Yealink T236 web user interface. The 'Features' tab is selected, and the 'General Information' sub-tab is active. The 'Dual-Headset' setting is highlighted with a red box and is set to 'Enabled'. Other settings include Call Waiting (Enabled), Call Waiting On Code (empty), Call Waiting Off Code (empty), Auto Redial (Disabled), Play Hold Tone (Enabled), Play Hold Tone Delay (30), Allow Mute (Enabled), Auto-Answer Delay (1~4s) (1), Enable auto answer tone (Enabled), Headset Prior (Disabled), Display Method on Dialing (User Name), and Auto Linekeys (Disabled). A 'NOTE' section on the right provides details for Call Waiting, Auto Redial, Key As Send, Hotline, and Call Completion.

3. Click **Confirm** to accept the change.

Note Dual headset is configurable via web user interface only.

DSS Keys

There are two types of DSS keys: Line Keys and Programable Keys. The details will be introduced in the following. The SIP-T23P/G IP phone supports 3 line keys and 11 programable keys. For more information on DSS key icon indicators, refer to [Icon Instructions](#) on page 12.

Line Keys

You can assign predefined functionalities to line keys. You can also define a label for a line key feature which will appear on the LCD screen. Line keys allow you to quickly access features such as recall and voice mail. The line key LEDs will indicate the

monitored status when the line keys are assigned with particular features, such as BLF. The default key type of each line key is Line.

To assign functionality to a line key via phone user interface:

1. Press **Menu->Features->DSS Keys**.
2. Select the desired DSS key, and then press the **Enter** soft key.
3. Select the desired key type from the **Type** field.
4. (Optional.) Select the desired key event type from the **Key Type** field.
5. (Optional.) Select the desired line from the **Account ID** field.
6. (Optional.) Enter the string that will appear on the LCD screen in the **Label** field.
7. (Optional.) Enter the corresponding value in the **Value** field.
8. (Optional.) Enter the corresponding value in the **Extension** field.
9. Press the **Save** soft key to accept the change or the **Back** soft key to cancel.

Line key is configurable via web user interface at the path **DSSKey->Line Key**.

Note

When the phone is idle, you can also long press the line key to configure it directly on the phone.

Line key features are explained in the following subchapters in detail:

- Line
- Speed Dial
- Voice Mail
- Direct Pickup
- Group Pickup
- DTMF
- Prefix
- Local Group
- XML Group
- XML Browser
- LDAP
- Conference
- Forward
- Transfer
- Hold
- DND
- SMS
- Group Listening

- Zero Touch
- URL
- Phone Lock
- Directory

For the features not listed above, refer to [Basic Call Features](#) on page 87 and [Advanced Phone Features](#) on page 121. For more information, contact your system administrator.

Line

You can use this key feature to accept incoming calls, place active calls on hold or resume a held call. It performs in the same way as a hard line key.

Dependencies: *Type (Line)*

Account ID (the account this feature will be applied to)

Label (key label displayed on the LCD screen)

Usage: When the phone receives an incoming call, the DSS key LED flashes green:

1. Press the DSS key to accept the incoming call.
2. Press the DSS key to place a new call and the active call is placed on hold.
3. Press the DSS key again to resume the held call.

Speed Dial

You can use this key feature to speed up dialing the numbers frequently used or hard to remember.

Dependencies: *Type (Speed Dial)*

Account ID (the account this feature will be applied to)

Label (key label displayed on the LCD screen)

Value (the number you want to dial out)

Usage: Press the DSS key to dial out the number specified in the **Value** field, using the account selected from the **Account ID** field.

Voice Mail

You can use this key feature to quickly connect voice mail. For more information, refer to [Voice Mail](#) on page 161.

Dependencies: *Type (Key Event)*

Key Type (Voice Mail)

Account ID (the account this feature will be applied to)

Label (key label displayed on the LCD screen)

Value (the voice mail access code)

Usage: Press the DSS key to dial out the voice mail access code. Then follow the voice prompt to listen to the voice mails.

Direct Pickup

You can use this key feature to answer someone else's incoming call on the phone.

Dependencies: *Type (Key Event)*

Key Type (DPickup)

Account ID (the account this feature will be applied to)

Label (key label displayed on the LCD screen)

Value (the directed pickup code followed by the target phone number)

Usage: Press the DSS key on your phone when the target phone number receives an incoming call. The call is then answered on your phone.

Group Pickup

You can use this key feature to answer incoming calls in a group that is associated with their own group.

Dependencies: *Type (Key Event)*

Key Type (GPickup)

Account ID (the account this feature will be applied to)

Label (key label displayed on the LCD screen)

Value (the group pickup feature code)

Usage: Press the DSS key on your phone when a phone number in the group receives an incoming call. The call is answered on your phone.

DTMF

You can use this key feature to send the specification of arbitrary key sequences via DTMF.

Dependencies: *Type (Key Event)*

Key Type (DTMF)

Label (key label displayed on the LCD screen)

Value (DTMF sequence)

Usage: Press the DSS key during an active call to send the key sequence specified in the **Value** field.

Note

DTMF sequence can only contain "0-9", "*", "#".

Prefix

You can use this key feature to add a specified prefix number before the dialed number.

Dependencies: *Type (Key Event)*

Key Type (Prefix)

Label (key label displayed on the LCD screen)

Value (the prefix number)

Usage: Press the DSS key when the phone is idle, the phone will then enter the pre-dialing screen and display the prefix number that you specified in the **Value** field. You can enter the remaining digits and then dial out.

Local Group

You can use this key feature to quickly access a contact group in the local directory. For more information, refer to [Local Directory](#) on page 47.

Dependencies: *Type (Key Event)*

Key Type (Local Group)

Local Group (the contact group name you want to access)

Label (key label displayed on the LCD screen)

Usage: Press the DSS key to access the contact group specified in the **Local Group** field.

XML Group

You can use this key feature to quickly access a remote group in your remote phone book. You should configure remote phone book in advance. For more information, refer to [Remote Phone Book](#) on page 59.

Dependencies: *Type (Key Event)*

Key Type (XML Group)

PhoneBook (the remote group name you want to access if remote phone book is configured)

Label (key label displayed on the LCD screen)

Usage: Press the DSS key to access the remote group specified in the **PhoneBook** field.

XML Browser

You can use this key feature to quickly access an XML browser. The XML browser allows you to create custom services which meet your functional requirements on the server. You can customize practical applications, such as weather report, stock information, Google search, etc.

Dependencies: *Type (XML Browser)*

Value (the access URL for XML browser)

Usage: Press the DSS key to access the XML browser specified in the **Value** field.

LDAP

You can use this key feature to quickly access a LDAP search screen.

Dependencies: *Type (Key Event)*

Key Type (LDAP)

Label (key label displayed on the LCD screen)

Usage:

1. Press the DSS key to access the LDAP search screen.

2. Enter a few continuous characters of the contact name or continuous numbers of the contact number using the keypad.

Conference

You can use this key feature to set up a conference call. For more information, refer to [Conference](#) on page 111.

Dependencies: *Type (Key Event)*

Key Type (Conf)

Label (key label displayed on the LCD screen)

Value (the number you want to add to the conference)

Usage: Press the DSS key during an active call to set up a conference with the number specified in the **Value** field.

Note

If the **Value** field is left blank, the DSS key performs the same as the **Conf** soft key during a call.

Forward

You can use this key feature to forward an incoming call to someone else. For more information, refer to [Call Forward](#) on page 102.

Dependencies: *Type (Key Event)*

Key Type (FWD)

Label (key label displayed on the LCD screen)

Value (the number you want to forward to)

Usage: Press the DSS key to forward an incoming call to the number specified in the **Value** field.

Note

If the **Value** field is left blank, the DSS key performs the same as the **FWD** soft key when receiving an incoming call.

Transfer

When there is an active call on the phone, you can use this key feature to handle the call differently depending on the transfer mode assigned to the DSS key.

Dependencies: *Type (Key Event)*

Key Type (Tran)

Label (key label displayed on the LCD screen)

Value (the number you want to transfer to)

Usage:

- When the transfer mode on DSS key is **Blind Transfer**, press the DSS key to complete the blind transfer to the number specified in the **Value** field.

- When the transfer mode on DSS key is **Attended Transfer**, press the DSS key to dial out the number specified in the **Value** field, and then perform the attended or semi-attended transfer.
- When the transfer mode on DSS key is **New Call**, press the DSS key to place a new call to the number specified in the **Value** field.

Note

Transfer mode via DSS key is configurable via web user interface at the path **Features->Transfer->Transfer Mode Via Dsskey**.

If the **Value** field is left blank, the DSS key performs the same as the **TRANSFER** key or the **Tran** soft key during a call. For more information, refer to [Call Transfer](#) on page 109.

Hold

You can use this key feature to place an active call on hold or retrieve a held call.

Dependencies: *Type (Key Event)*

Key Type (Hold)

Label (key label displayed on the LCD screen)

Usage:

1. Press the DSS key during an active call to place the call on hold.
2. Press the DSS key again to retrieve the held call.

DND

You can use this key feature to activate or deactivate DND. You can also use this key feature to access the custom DND screen. For more information, refer to [Do Not Disturb \(DND\)](#) on page 98.

Dependencies: *Type (Key Event)*

Key Type (DND)

Label (key label displayed on the LCD screen)

Usage:

When DND is in phone mode:

Press the DSS key to activate DND.

Press the DSS key again to deactivate DND.

When DND is in custom mode:

1. Press the DSS key to access the custom DND screen. You can activate or deactivate DND for one or all accounts.

Note

When DND is activated, the DND key LED will illuminate solid green, and the incoming calls will be rejected automatically.

SMS

You can use this key feature to quickly access text message. For more information, refer to [Short Message Service \(SMS\)](#) on page 158.

Dependencies: *Type (Key Event)*

Key Type (SMS)

Label (key label displayed on the LCD screen)

Usage: Press the DSS key when the phone is idle to access text message.

Group Listening

You can use this key feature to activate the Speakerphone and Handset/Headset mode at the same time. It is suitable for the group conversations which have more than one person present at one end. You are able to speak and listen through the handset/headset, while the others nearby can only listen through the speaker.

Dependencies: *Type (Key Event)*

Key Type (Group Listening)

Label (key label displayed on the LCD screen)

Usage:

1. During a call, press the DSS key to activate the group listening mode.
You can then speak and listen through the handset/headset, while other people at your side can only listen through the speaker at the same time.
2. Press the DSS key again to deactivate the group listening mode.

Zero Touch

You can use this key feature to quickly configure auto provision and network parameters.

Dependencies: *Type (Key Event)*

Key Type (Zero Touch)

Label (key label displayed on the LCD screen)

Usage:

1. Press the DSS key to access the zero touch screen.
2. Press the **OK** soft key within a few seconds.
3. Configure the network parameters in the corresponding fields.
4. Press the **Next** soft key.
5. Configure the auto provision parameters in the corresponding fields.
6. Press the **OK** soft key.

The phone will reboot to update configurations.

URL

You can use this key feature to trigger the phone to send an HTTP GET request

containing a specific URL.

Dependencies: *Type (URL)*

Value (the URL contained in the HTTP GET request)

Label (key label displayed on the LCD screen)

Usage: Press the DSS key to trigger the phone to send an HTTP GET request containing the URL specified in the *Value* field.

Phone Lock

You can use this key feature to immediately lock your phone instead of long pressing . For more information, refer to [Phone Lock](#) on page 40.

Dependencies: *Type (Phone Lock)*

Usage: When the phone lock feature is enabled, press the DSS key to immediately lock your phone instead of long pressing .

Directory

You can use this key feature to easily access frequently used lists. For more information, refer to [Directory](#) on page 46.

Dependencies: *Type (Dir)*

Label (key label displayed on the LCD screen)

Usage: Press the DSS key to immediately access to frequently used lists.

Note The DSS key performs the same function as the **Dir** soft key when the phone is idle.

Programable Keys

You can customize the soft keys, navigation keys and function keys.

To customize the programable keys via web user interface:

1. Click on **DSSKey->Programable Key**.
2. Customize specific features for these keys.

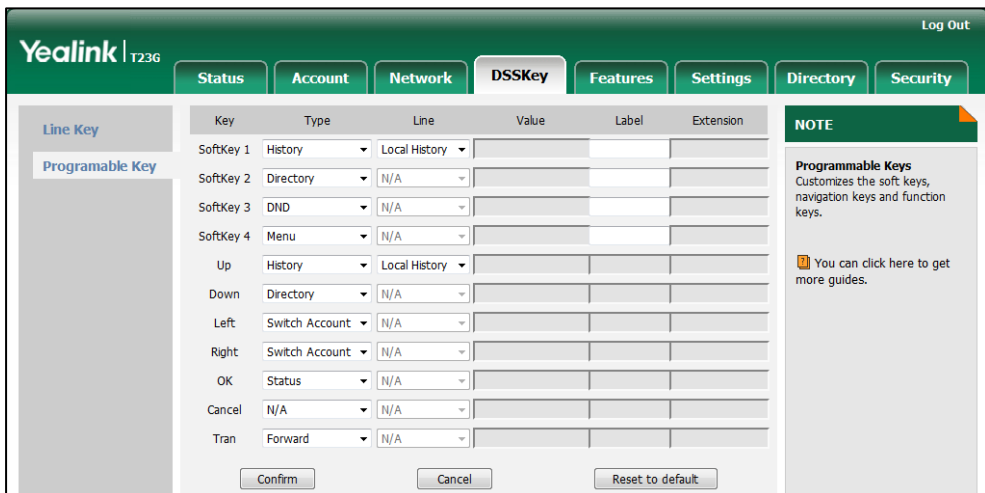

3. (Optional.) Enter the string that will appear on the LCD screen in the **Label** field.
Label is configurable only when customizing SoftKey (1-4).

4. Click **Confirm** to accept the change.

You can click **Reset to default** to reset custom settings to defaults.

Then you can press the keys on the phone to perform the features you configured.

For example:

Switch Account Up

You can press **Switch Account Up** key to change the default account.

Dependencies: *Type (Switch Account Up)*

Usage: Press the **Switch Account Up** key to scroll up the account list to select the desired default account.

Switch Account Down

You can press **Switch Account Down** key to change the default account.

Dependencies: *Type (Switch Account Down)*

Usage: Press the **Switch Account Down** key to scroll down the account list to select the desired default account.

Note

Programmable keys are configurable via web user interface only.

Account Management

You can register one or multiple accounts on the SIP-T23P/G IP phone. You can also configure each line key to associate with an account or configure multiple line keys to associate with an account.

Account Registration

To register an account via phone user interface:

1. Press **Menu->Settings->Advanced Settings** (default password: admin)
->**Accounts**.
2. Select the desired account and then press the **Enter** soft key.

3. Select **Enabled** from the **Active Line** field.

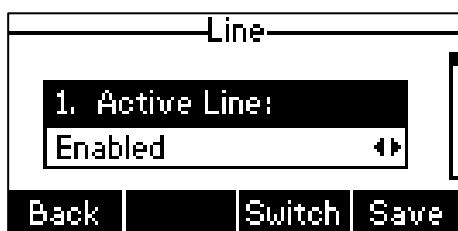

4. Enter the desired value in **Label**, **Display Name**, **Register Name**, **User Name**, **Password** and **SIP Server1/2** field respectively. Contact your system administrator for more information.
5. If you use the outbound proxy servers, do the following:
 - 1) Press **◀** or **▶**, or the **Switch** soft key to select **Enabled** from the **Outbound Status** field.
 - 2) Enter the desired value in the **Outbound Proxy1/2** and **Proxy Fallback Interval** field respectively. Contact your system administrator for more information.
6. Press the **Save** soft key to accept the change or the **Back** soft key to cancel.

You can repeat steps 2 to 6 to register more accounts.

To disable an account via phone user interface:

1. Press **Menu->Settings->Advanced Settings** (default password: admin) **->Accounts**.
2. Select the desired account and then press the **Enter** soft key.
3. Select **Disabled** from the **Active Line** field.
4. Press the **Save** soft key to accept the change or the **Back** soft key to cancel.

Account registration is configurable via web user interface at the path

Account->Register.

Note Default account can be set by pressing **◀** or **▶** on the idle screen. It has priority when placing a call. The phone's default account cannot be changed after reboot.

Multiple Line Keys per Account

You can configure multiple line keys to associate with an account. This enhances call visualization and simplifies call handling.

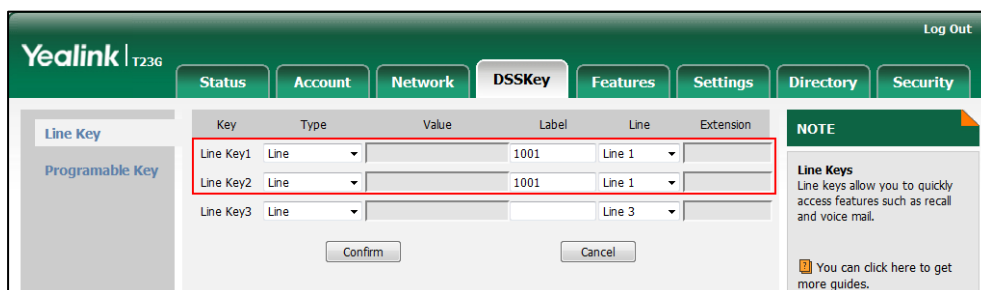

If this is the case, the LCD screen will resemble the following figure:



Incoming calls to this account will be distributed evenly among the available line keys. Outgoing calls will be distributed similarly.

Your phone can be configured to have a combination of accounts with a single line key and accounts with multiple line keys.

Dial Plan

Dial plan is a string of characters that governs the way your SIP-T23P/G IP phone processes the inputs received from your phone keypad. The SIP-T23P/G IP phone supports the following dial plan features:

- [Replace Rule](#)
- [Dial-now](#)
- [Area Code](#)
- [Block Out](#)

The basic expression syntax you need to know:

.	The dot "." can be used as a placeholder or multiple placeholders for any character. Example: "12." would match "123", "1234", "12345", "12abc", etc.
x	An "x" can be used as a placeholder for any character. Example: "12x" would match "121", "122", "123", "12a", etc.

-	Numeric ranges are allowed within the brackets: Digit "-" Digit. Example: "[5-7]" would match the number "5", "6" or "7".
[]	The square brackets "[]" can be used as a placeholder for a single character which matches any of a set of characters. Example: "91[5-7]1234" would match "9151234", "9161234", "9171234".
()	The parentheses "(" ")" can be used to group together patterns, for instance, to logically combine two or more patterns. Example: "([1-9])([2-7])3" would match "923", "153", "773", etc.
\$	The "\$" should be followed by the sequence number of a parenthesis. The "\$" plus the sequence number means the whole character or characters placed in the parenthesis. The number directs to the right parenthesis when there are more than one. Example: A replace rule configuration, Prefix: "001(xxx)45(xx)", Replace: "9001\$145\$2". When you dial out "0012354599" on your phone, the IP phone will replace the number with "90012354599". "\$1" means 3 digits in the first parenthesis, that is, "235". "\$2" means 2 digits in the second parenthesis, that is, "99".

Replace Rule

You can configure one or more replace rules (up to 100) to remove the specified string and replace it with another string. You can configure a pattern with wildcards (refer to the expression syntax in the table above), so that any string that matches the pattern will be replaced. This feature is convenient for you to dial out a long number. For example, a replace rule is configured as "Prefix: 1" and "Replace: 1234". When trying to dial out the number "1234", you just need to enter "1" on the phone and then press the **Send** soft key.

To add a replace rule via web user interface:

1. Click on **Settings->Dial Plan->Replace Rule**.
2. Enter the string (e.g., 1) in the **Prefix** field.
3. Enter the string (e.g., 1234) in the **Replace** field.

4. Enter the desired line ID in the **Account** field or leave it blank.

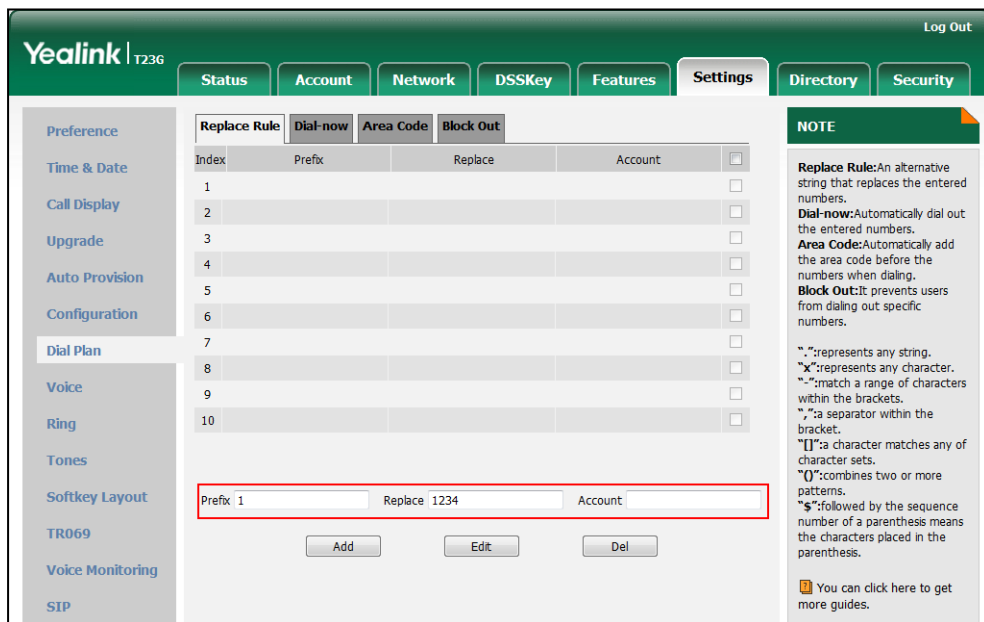

5. Click **Add** to add the replace rule.
When you enter the number “1” using the keypad and then press the **Send** soft key, the phone will dial out “1234” instead.

Note The valid values of **Account** field can be one or more digits among 1-3. Every two digits must be separated by a comma. For example, when you enter the value “1, 2” in the **Account** field, this replace rule will apply to account1 and account2.
If you leave the **Account** field blank or enter 0, the replace rule will apply to all accounts.

To edit a replace rule via web user interface:

1. Click on **Settings->Dial Plan->Replace Rule**.
2. Select the desired replace rule by checking the check box.
3. Edit the values in the **Prefix** and **Replace** fields.
4. Enter the desired line ID in the **Account** field or leave it blank.
5. Click **Edit** to accept the change.

To delete one or more replace rules via web user interface:

1. Click on **Settings->Dial Plan->Replace Rule**.
2. Select one or more replace rules by checking the check box(es).
3. Click **Del** to delete the replace rule(s).

Note Replace rule is configurable via web user interface only.

Dial-now

You can configure one or more dial-now rules (up to 100) on your phone. When the dialed number matches the dial-now string, the number will be dialed out automatically. For example, a dial-now rule is configured as "1xx", any entered three-digit string beginning with 1 will then be dialed out automatically on the phone.

To add a dial-now rule via web user interface:

1. Click on **Settings->Dial Plan->Dial-now**.
2. Enter the desired value (e.g., 1xx) in the **Rule** field.
3. Enter the desired line ID in the **Account** field or leave it blank.

For more information on the valid values for the **Account** field, refer to [Replace Rule](#) on page 78.

The screenshot shows the 'Dial-now' configuration page in the Yealink T23G web interface. The page is titled 'Yealink T23G' and has a 'Log Out' button in the top right corner. The navigation menu includes 'Status', 'Account', 'Network', 'DSSKey', 'Features', 'Settings', 'Directory', and 'Security'. The 'Settings' tab is selected, and the 'Dial Plan' sub-tab is active. A table with columns 'Index', 'Dial-now Rule', and 'Account' is displayed, with rows 1 through 10. Below the table are input fields for 'Rule 1xx' and 'Account', and 'Add', 'Edit', and 'Del' buttons. A 'NOTE' section on the right explains the fields and provides a legend for special characters.

Index	Dial-now Rule	Account
1		
2		
3		
4		
5		
6		
7		
8		
9		
10		

NOTE

Replace Rule: An alternative string that replaces the entered numbers.
Dial-now: Automatically dial out the entered numbers.
Area Code: Automatically add the area code before the numbers when dialing.
Block Out: It prevents users from dialing out specific numbers.

","; represents any string.
"x"; represents any character.
"-"; match a range of characters within the brackets.
";"; a separator within the bracket.
"[]""; a character matches any of character sets.
"()"; combines two or more patterns.
"\$"; followed by the sequence number of a parenthesis means the characters placed in the parenthesis.

You can click here to get more guides.

4. Click **Add** to add the dial-now rule.

When you enter the number "123" using the keypad, the phone will dial out "123" automatically without pressing any key.

Note

You can also edit or delete the dial-now rule, refer to [Replace Rule](#) on page 78 for more information.

Dial-now rule is configurable via web user interface only.

Delay Time for Dial-now Rule

You can configure the delay time for dial-now rules. That is, you can configure your phone to automatically dial out the phone number which matches a dial-now rule, after the designated delay time.

To configure the delay time for dial-now rule via web user interface:

1. Click on **Features->General Information**.
2. Enter the time between 0 and 14 (seconds) in the **Time-Out for Dial-Now Rule** field.
The default value is "1".

The screenshot shows the Yealink T236 web user interface. The 'Features' tab is selected, and the 'General Information' sub-tab is active. The 'Time-Out for Dial-Now Rule' field is highlighted with a red box and contains the value '1'. Other settings include Call Waiting (Enabled), Call Waiting On Code, Call Waiting Off Code, Auto Redial (Disabled), Auto Redial Interval (1~300s) (10), Auto Redial Times (1~300) (10), Key As Send (#), Reserve # in User Name (Enabled), Hotline Number, Hotline Delay(0~10s) (4), Busy Tone Delay (Seconds) (0), Return Code When Refuse (486 (Busy Here)), Return Code When DND (480 (Temporarily Unavail)), Call Completion (Disabled), Feature Key Synchronization (Disabled), RFC 2543 Hold (Disabled), and Use Outbound Proxy In Dialog (Enabled). A 'NOTE' section on the right provides details for Call Waiting, Auto Redial, Key As Send, Hotline, and Call Completion.

3. Click **Confirm** to accept the change.

Note Delay time for dial-now rule is configurable via web user interface only.

Area Code

Area codes are also known as Numbering Plan Areas (NPAs). They usually indicate geographical areas in a country. This feature is necessary when dialing a phone number outside the code area. For example, an area code is configured as "Code: 0592, Min Length: 1, Max Length: 15". When you dial out the number "56789" (the length of the number is between 1 and 15), the phone will add the area code and dial out the number "059256789". You can only configure one area code rule on your phone.

To configure the area code via web user interface:

1. Click on **Settings->Dial Plan->Area Code**.
2. Enter the desired values in the **Code**, **Min Length (1-15)** and **Max Length (1-15)** fields.
3. Enter the desired line ID in the **Account** field or leave it blank.

For more information on the valid values for the **Account** field, refer to [Replace Rule](#) on page 78.

The screenshot shows the Yealink T236 web interface. The 'Settings' tab is active, and the 'Block Out' sub-tab is selected. The configuration form includes the following fields:

Code	0592
Min Length (1-15)	1
Max Length (1-15)	15
Account	

Buttons for 'Confirm' and 'Cancel' are visible below the form. A 'NOTE' box on the right contains the following information:

Replace Rule: An alternative string that replaces the entered numbers.
Dial-now: Automatically dial out the entered numbers.
Area Code: Automatically add the area code before the numbers when dialing.
Block Out: It prevents users from dialing out specific numbers.

Legend:
 ".": represents any string.
 "x": represents any character.
 "-": match a range of characters within the brackets.
 ",": a separator within the bracket.
 "[]": a character matches any of character sets.
 "()": combines two or more patterns.
 "*": followed by the sequence number of a parenthesis means the characters placed in the parenthesis.

You can click here to get more guides.

4. Click **Confirm** to accept the change.

Note The default value of minimum and maximum length is 1 and 15 respectively. Area code is configurable via web user interface only.

Block Out

You can block some specific numbers (up to 10) from being dialed on your phone. When you dial a block out number on your phone, the dialing will fail and the LCD screen will prompt "Forbidden Number".

To add a block out number via web user interface:

1. Click on **Settings->Dial Plan->Block Out**.
2. Enter the desired value in the **BlockOut Number** field.
3. Enter the desired line ID in the **Account** field or leave it blank.

For more information on the valid values for the **Account** field, refer to [Replace Rule](#) on page 78.

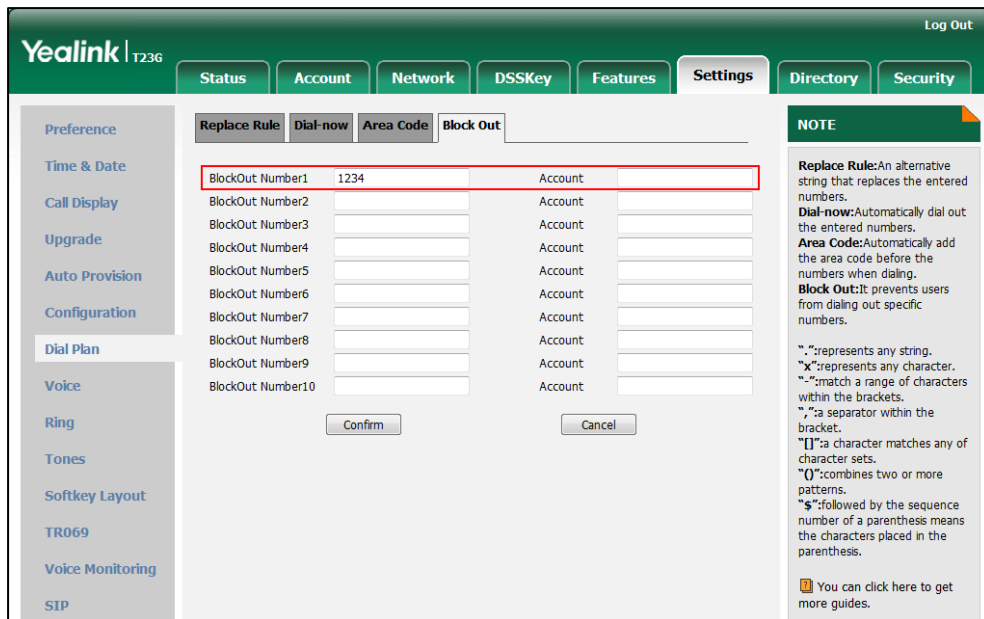

4. Click **Confirm** to add the block out number.

Note Block out number is configurable via web user interface only.

Emergency Number

Public telephone networks in countries around the world have a single emergency telephone number (emergency services number), that allows a caller to contact local emergency services for assistance when necessary. The emergency telephone number may differ from country to country. It is typically a three-digit number so that it can be easily remembered and dialed quickly. Some countries have a different emergency number for each of the different emergency services.

You can specify the emergency telephone numbers on the IP phone for contacting the emergency services in an emergency situation. You can dial these numbers when the phone is locked. For more information on phone lock, refer to [Phone Lock](#) on page 40.

Note Contact your local phone service provider for available emergency numbers in your area.

To specify emergency numbers via web user interface:

1. Click on **Features->Phone Lock**.
2. Enter the emergency number in the **Emergency** field.

For multiple numbers, enter a comma between every two emergency numbers. The default emergency numbers are 112, 911, 110.

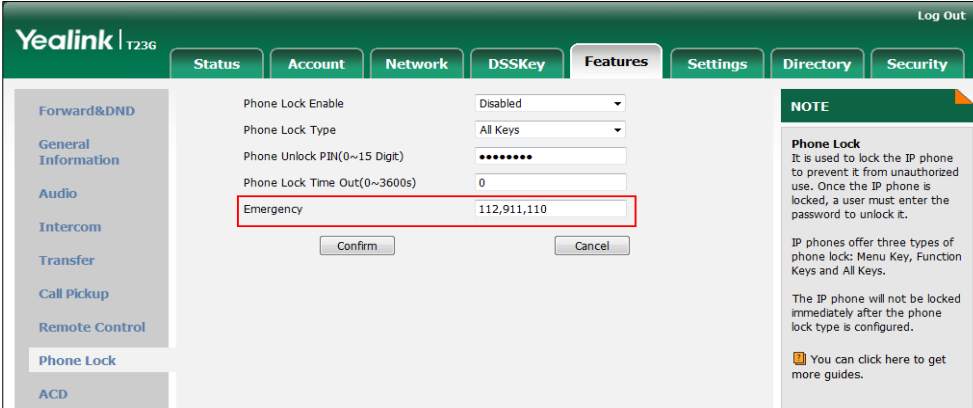

The screenshot shows the Yealink T236 web interface. The top navigation bar includes 'Status', 'Account', 'Network', 'DSSKey', 'Features', 'Settings', 'Directory', and 'Security'. The 'Features' tab is selected. On the left sidebar, 'Phone Lock' is highlighted. The main content area shows the following configuration options:

- Phone Lock Enable: Disabled
- Phone Lock Type: All Keys
- Phone Unlock PIN(0~15 Digit):
- Phone Lock Time Out(0~3600s): 0
- Emergency: 112,911,110 (highlighted with a red box)

Buttons for 'Confirm' and 'Cancel' are located below the 'Emergency' field. A 'NOTE' box on the right contains the following text:

Phone Lock
It is used to lock the IP phone to prevent it from unauthorized use. Once the IP phone is locked, a user must enter the password to unlock it.

IP phones offer three types of phone lock: Menu Key, Function Keys and All Keys.

The IP phone will not be locked immediately after the phone lock type is configured.

You can click here to get more guides.

3. Click **Confirm** to accept the change.

Note Emergency number is configurable via web user interface only.

Live Dialpad

You can enable live dialpad feature on the SIP-T23P/G IP phone, which enables the IP phone to automatically dial out a phone number without pressing the send key. You can also configure a delay, and then the phone will dial out the phone number automatically after the designated period of time.

To enable live dialpad via web user interface:

1. Click on **Settings->Preference**.
2. Select **Enabled** from the pull-down list of **Live Dialpad**.
3. Enter the desired delay time in the **Inter Digit Time(1~14s)** field.

The default delay time is 4 seconds.

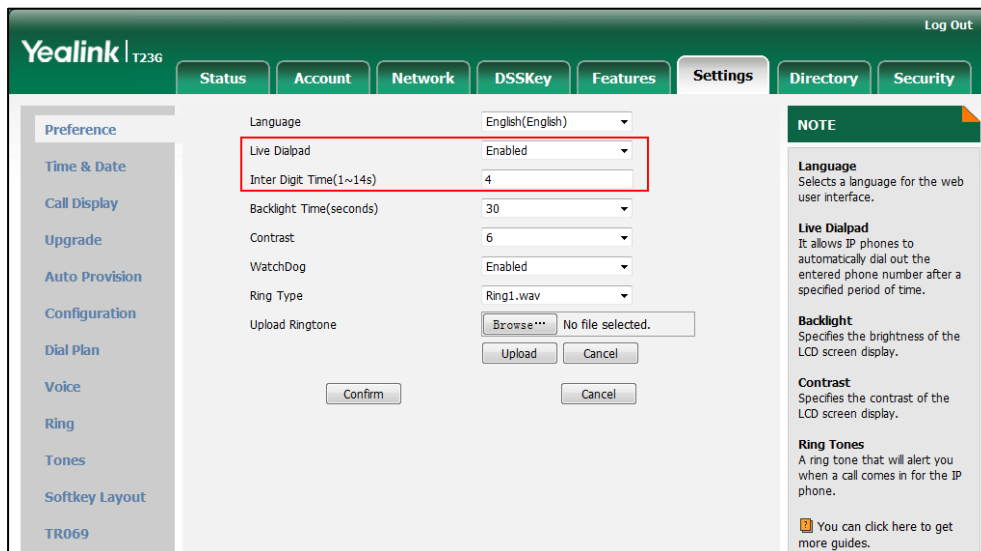

4. Click **Confirm** to accept the change.

Note Live dialpad is configurable via web user interface only.

Hotline

You can dial a hotline number immediately upon lifting the handset, pressing the Speakerphone key or the line key. You can also configure a delay, and then the phone will dial out the hotline number automatically after the designated period of time.

To configure the hot line number via phone user interface:

1. Press **Menu->Features->Hot Line**.
2. Enter the desired number in the **Hot Number** field.

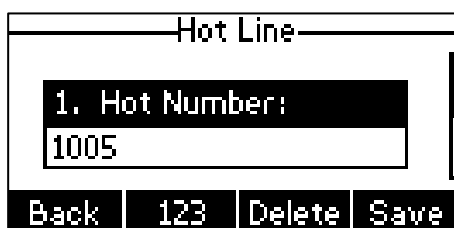

3. Enter the delay time in the **Hotline Delay** field.
The valid values range from 0 to 10 (seconds) and the default value is "4".
4. Press the **Save** soft key to accept the change or the **Back** soft key to cancel.

Hotline is configurable via web user interface at the path **Features->General Information**.

Basic Call Features

The SIP-T23P/G IP phone is designed to be easily used like a regular phone on a public switched telephone network (PSTN). You can place calls, answer calls, transfer a call to someone else, or conduct a conference call.

This chapter provides basic operating instructions for the SIP-T23P/G IP phone. Topics include:

- [Placing Calls](#)
- [Answering Calls](#)
- [Ending Calls](#)
- [Redialing Numbers](#)
- [Recent Call In Dialing](#)
- [Auto Answer](#)
- [Auto Redial](#)
- [Call Completion](#)
- [ReCall](#)
- [Call Mute](#)
- [Call Hold/Resume](#)
- [Do Not Disturb \(DND\)](#)
- [Call Forward](#)
- [Call Transfer](#)
- [Call Waiting](#)
- [Conference](#)
- [Call Park](#)
- [Call Pickup](#)
- [Anonymous Call](#)
- [Anonymous Call Rejection](#)

If you require additional information or assistance with your new phone, contact your system administrator.

Placing Calls

You can place a call in one of three ways using your SIP-T23P/G IP phone:

- Using the handset
- Using the speakerphone
- Using the headset

You can also dial the number first, and then choose the way you want to speak to the other party.



You can also search and dial a contact from call history, local directory or remote phone book. For more information, refer to [Contact Management](#) on page 46 and [Call History Management](#) on page 61.

During a call, you can alternate between Speakerphone, Headset and Handset modes by pressing the Speakerphone key, the HEADSET key, or by picking up the handset.

The call duration of the active call and far-site's information (name or phone number) are visible on the LCD screen. In the figure below, the call to "Alin" (the phone number: 1020) has lasted 5 seconds.



To place a call using the handset:

1. Pick up the handset.
2. Enter the desired number using the keypad.
3. Press  ,  , or the **Send** soft key.

The # key is configured as a send key by default. You can also set the * key as the send key, or set neither. For more information, refer to [Key as Send](#) on page 40.

Note

You can also dial using the SIP URI or IP address. To obtain the IP address of a phone, press the **OK** key when the phone is idle. The maximum SIP URI or IP address length is 32 characters. For example, SIP URI: 2210@sip.com, IP: 192.168.1.15.



Your phone may not support direct IP dialing. Contact your system administrator for more information.

To place a call using the hands-free speakerphone mode:

Do one of the following:

- With the handset on-hook, press  or the line key to obtain a dial tone.

Enter the desired number using the keypad.

Press , , or the **Send** soft key.

- With the handset on-hook, enter the desired number using the keypad.

Press , , , or the **Send** soft key.



To place a call using the headset:

Do one of the following:

- With the optional headset connected, press  to activate the headset mode.



Press the line key to obtain a dial tone.

Enter the desired number using the keypad.

Press , , or the **Send** soft key.

- With the optional headset connected, press  to activate the headset mode.

Enter the desired number using the keypad.

Press , , or the **Send** soft key.

Note

To permanently use the headset mode, refer to [Headset Prior](#) on page 65.



The SIP-T23P/G IP phone can handle multiple calls at a time. However, only one active call (the call that has audio associated with it) can be in progress at any time, other calls are placed on hold. The SIP-T23P/G IP phone can handle a maximum of 50 calls at one time.

To place multiple calls:

You can have more than one call on your SIP-T23P/G IP phone. To place a new call during an active call, do one of the following:

- Press the line key. The active call is placed on hold.



Enter the desired number using the keypad.



Press , , or the **Send** soft key.

- Press the **Hold** soft key to place the original call on hold.

Press the **NewCall** soft key.

Enter the desired number using the keypad.

Press , , or the **Send** soft key.

You can press  or  to switch between calls, and then press the **Resume** soft key to retrieve the desired call.

Note

If multiple accounts are registered on the phone, you can first press the desired line key on the idle screen or press the Line soft key on the dialing screen, and then you can use the selected account to place a call.

Answering Calls

When you are not in another call, you can answer a call in one of three ways:

- Using the handset
- Using the speakerphone
- Using the headset

Note

You can reject incoming calls by pressing the **Reject** soft key or the **X** key. You can also activate Do Not Disturb mode to ignore all incoming calls without ring on your phone. For more information, refer to [Do Not Disturb \(DND\)](#) on page 98.

You can forward incoming calls to someone else by pressing the **FWD** soft key. For more information, refer to [Call Forward](#) on page 102.

Answering When Not in Another Call

Call duration and destination will always appear on the LCD screen for the active call.

To answer a call using the handset:

1. Pick up the handset.

To answer a call using the hands-free speakerphone mode:

Do one of the following:

- Press  .
- With the handset on-hook and the headset mode deactivated, press the **Answer** soft key.
- With the handset on-hook and the headset mode deactivated, press the line key with the fast flashing green LED indicator.

To answer a call using the headset:

Do one of the following:



- Press  .
- With the headset mode activated, press the **Answer** soft key.
- With the headset mode activated, press the line key with the fast flashing green LED indicator.

Answering When in Another Call

If you have an active call, and an incoming call arrives on the phone, do one of the following:

- Press the **Answer** soft key.

The incoming call is answered and the original call is placed on hold.

- Press  to access the new call.
- Press  or the **Answer** soft key.

The incoming call is answered and the original call is placed on hold.

Ending Calls

To end a call:

Do one of the following:





- If you are using the handset, press the **EndCall** soft key or hang up the handset.
- If you are using the headset, press the **EndCall** soft key.
- If you are using the speakerphone, press  or the **EndCall** soft key.

Redialing Numbers

To redial the last dialed number from your phone:

1. Press  twice.
A call to your last dialed number is attempted.

To redial a previously dialed number from your phone:

1. Press  when the phone is idle.
2. Press  or  to select the desired entry from the placed calls list, and then press  or the **Send** soft key.

Recent Call In Dialing

To view the placed calls list when the phone is on the pre-dialing screen, you should enable recent call in dialing in advance.

To enable recent call in dialing via web user interface:

1. Click on **Directory->Setting**.

2. Select **Enabled** from the pull-down list of **Recent Call In Dialing**.

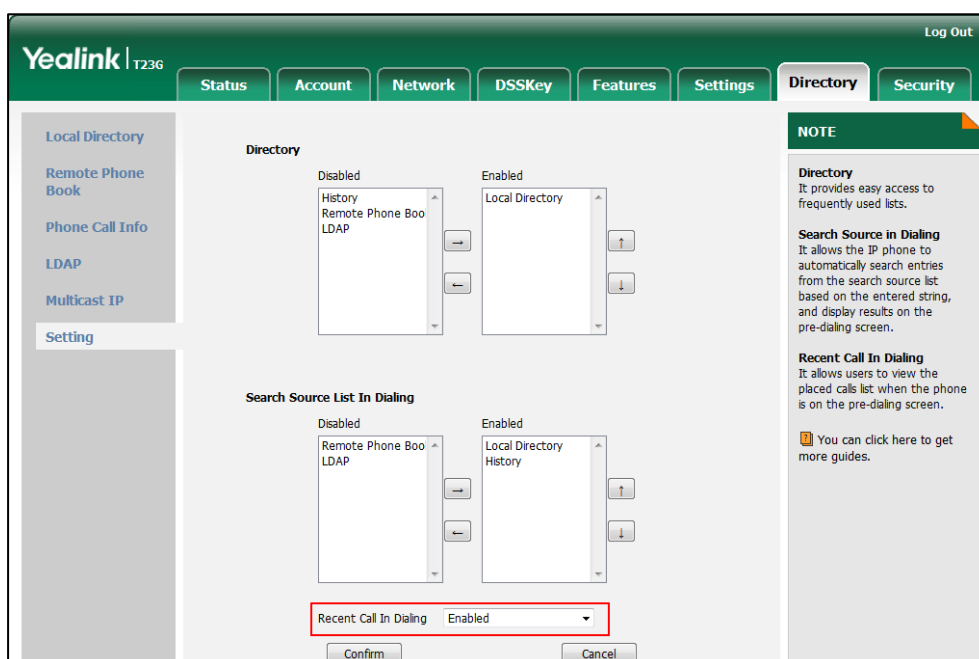

3. Click **Confirm** to accept the change.

Note

Recent call in dialing is configurable via web user interface only.

To view placed calls list when the phone is on the pre-dialing screen:

1. Pick up the handset, press the Speakerphone key or press the line key.
The LCD screen displays the placed calls list.

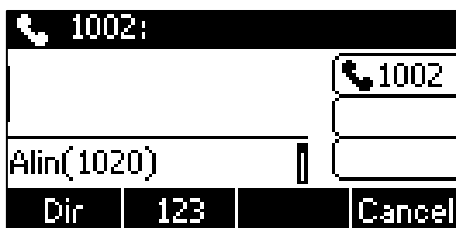

You can also enter a few continuous characters of the contact name or continuous numbers of the contact number (office, mobile or other number) to search from placed calls list.

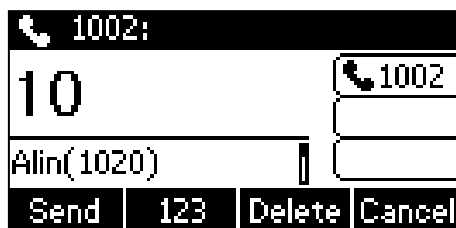

Auto Answer

You can use auto answer feature to automatically answer an incoming call on a line. Auto answer is configurable on a per-line basis.

To configure auto answer via phone user interface:

1. Press **Menu->Features->Auto Answer**.
2. Press \leftarrow or \rightarrow , or the **Switch** soft key to select the desired account from the **Line ID** field.
3. Press \leftarrow or \rightarrow , or the **Switch** soft key to select **Enabled** from the **Status** field.

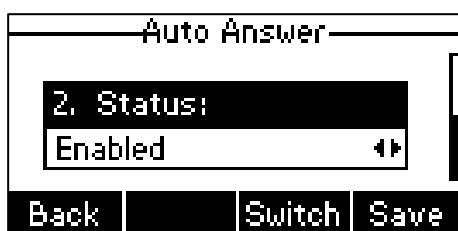

4. Press the **Save** soft key to accept the change or the **Back** soft key to cancel. The \boxed{AA} icon appears on the LCD screen.

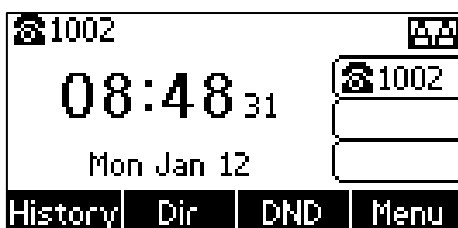



Auto answer is configurable via web user interface at the path **Account->Basic**.

Note Auto answer is only applicable when there is no other call in progress on the phone.

Auto Redial

You can enable auto redial to automatically redial a phone number when the called party is busy. You can also configure the number of auto redial attempts and the time to wait between redial attempts.

To configure auto redial via phone user interface:

1. Press **Menu->Features->Auto Redial**.
2. Press  or , or the **Switch** soft key to select **Enabled** from the **Auto Redial** field.



3. Enter the desired time (in seconds) in the **Redial Interval** field.
The default value is "10".
4. Enter the desired number of redial attempts in the **Redial Times** field.
The default value is "10".
5. Press the **Save** soft key to accept the change or the **Back** soft key to cancel.

Auto redial is configurable via web user interface at the path **Features->General Information**.

To use auto redial:

When the called party is busy, the following prompt will appear on the LCD screen of the phone:



1. Press the **OK** soft key to activate auto redial. The following prompt will appear on the LCD screen of the phone:

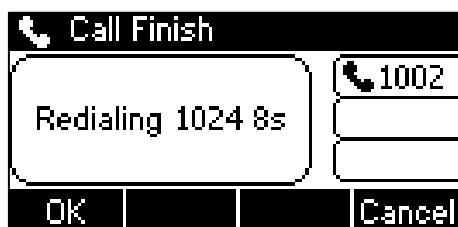

2. Wait for the designated period of time or press the **OK** soft key to redial the phone number.

The phone will retry as many times as configured until the called party is idle.

Call Completion

You can use call completion to notify the caller who failed to reach a desired party when the party becomes available to receive a call.

To configure call completion via phone user interface:

1. Press **Menu->Features->Call Completion**.
2. Press ◀ or ▶, or the **Switch** soft key to select **Enabled** from the **Call Completion** field.

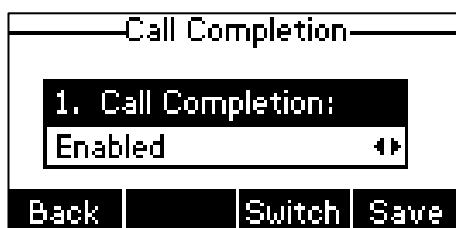

3. Press the **Save** soft key to accept the change or the **Back** soft key to cancel.

Call completion is configurable via web user interface at the path **Features->General Information**.

To use call completion:

When the called party is busy, the following prompt will appear on the LCD screen of the phone:

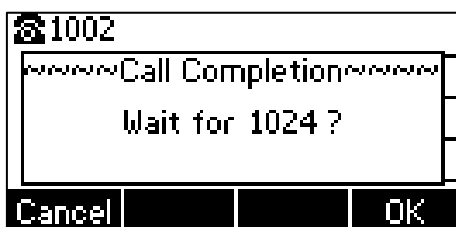

1. Press the **OK** soft key, the phone returns to the idle screen and call completion is activated.

When the called party becomes idle, the following prompt will appear on the LCD screen of the phone:

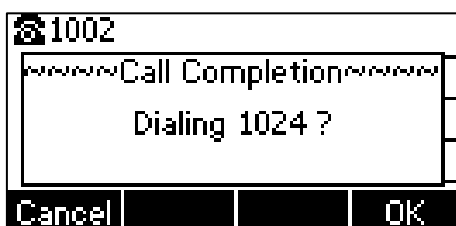

1. Press the **OK** soft key to redial the number.

Note

Call completion is not available on all servers. For more information, contact your system administrator.

ReCall

You can press a recall key to place a call back to the last incoming call.

To configure a recall key via phone user interface:

1. Press **Menu->Features->DSS Keys**.
2. Select the desired DSS key.
3. Press ◀ or ▶, or the **Switch** soft key to select **Key Event** from the **Type** field.
4. Press ◀ or ▶, or the **Switch** soft key to select **ReCall** from the **Key Type** field.

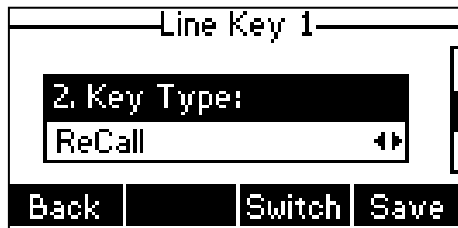

5. (Optional.) Enter the string that will appear on the LCD screen in the **Label** field.
6. Press the **Save** soft key to accept the change or the **Back** soft key to cancel.

Recall key is configurable via web user interface at the path **DSSKey->Line Key**.

Call Mute

You can mute the microphone of the active audio device during an active call so that the other party cannot hear you. Call mute applies to all modes (Handset, Headset and Speakerphone).

To mute a call:

1. Press (x) during an active call.

The LCD screen indicates that the call is now muted.



To un-mute a call:

1. Press  again to un-mute the call.

Call Hold/Resume

You can place an active call on hold. Only one active call can be in progress at any time. Other calls can be made and received while placing the original call on hold. When you place a call on hold, your IP PBX may play music to the other party while waiting.

To place a call on hold:

1. Press the **Hold** soft key during a call.

The line key LED flashes green. The LCD screen indicates that the call is on hold.

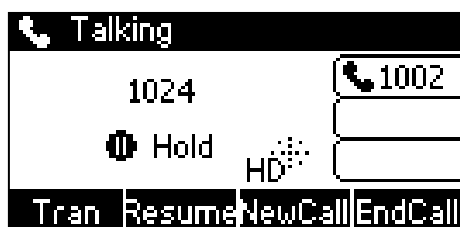
**Note**



The phone will beep softly every 30 seconds to remind you that you still have a call on hold.

To resume a held call:

1. Press the **Resume** soft key.

Multiple Calls on Hold:

If multiple calls are placed on hold, do one of the following:

- Press  or  to switch between the calls, and then press the **Resume** soft key to retrieve the desired call.
- Press the corresponding line key to retrieve the call.

If more than one call is placed on hold, a numbered prompt appears on the LCD screen, for example "2/3", indicating that this is the second call out of three calls.

Do Not Disturb (DND)

You can use DND to reject incoming calls automatically on the phone. The prompt message "**n New Missed Call(s)**" ("n" indicates the number of missed calls) will appear on the LCD screen, and callers will receive a busy message. All calls you receive while DND is enabled are logged to your missed calls list.

Note

The prompt message will display only if Missed Call Log for the line is enabled. Missed call log is configurable via web user interface at the path **Account->Basic->Missed Call Log**.

Do not disturb is local to the phone, and may be overridden by the server settings. For more information, contact your system administrator.

You can enable/disable DND for the phone system, or you can customize DND for each or all accounts. Two DND modes:

- **Phone** (default): DND is effective for the phone system.
- **Custom**: DND can be configured for each or all accounts.

You can receive incoming calls from authorized numbers when DND is enabled.

To configure the DND mode via web user interface:

1. Click on **Features->Forward & DND**.

- In the **DND** block, mark the desired radio box in the **Mode** field.

The screenshot shows the Yealink T23G web interface with the 'Features' tab selected. The 'Forward&DND' section is active, and the 'DND' configuration is visible. The 'Mode' field is highlighted with a red box, showing 'Phone' selected. The 'Account' field is set to '1002'. The 'DND Status' is set to 'Off'. The 'DND On Code' and 'DND Off Code' fields are empty. The 'Confirm' and 'Cancel' buttons are at the bottom.

- Click **Confirm** to accept the change.

Note

DND mode is configurable via web user interface only.

To activate DND in phone mode:

- Press the **DND** soft key when the phone is idle.
The  icon on the status bar indicates that DND is enabled.

Incoming calls will be rejected automatically and "n New Missed Call(s)" ("n" indicates the number of missed calls. e.g., 1 New Missed Call(s)) will appear on the LCD screen.



Note





When DND and busy forward are enabled in phone mode, calls will be sent to the configured destination number. For more information on busy forward, refer to [Call Forward](#) on page 102.

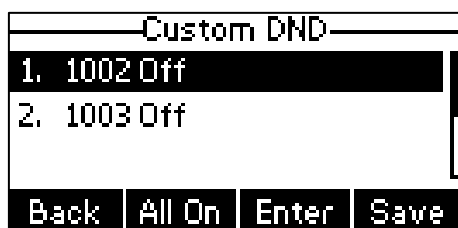

To activate DND in custom mode for a specific account:

1. Press the **DND** soft key when the phone is idle.

The LCD screen displays a list of accounts registered on the phone.



2. Press  or  to select the desired account and then press the **Enter** soft key.
3. Press  or , or the **Switch** soft key to select **Enabled** from the **DND Enable** field.
4. Press the **Save** soft key to accept the change.

If you activate DND for the default account, the associated line icon will change to , and the  icon will appear on the status bar.

If you activate DND for the non-default account, only the associated line icon will change to .

Incoming calls on the specific line will be rejected automatically, and the LCD screen will prompt "**n New Missed Call(s)**" ("n" indicates the number of missed calls. e.g., 1 New Missed Call(s)).



Note

When DND and busy forward are both enabled for a specific account, calls to the specific account will be sent to the configured destination number. For more information on call forward, refer to [Call Forward](#) on page 102.

To activate DND in custom mode for all accounts:

1. Press the **DND** soft key when the phone is idle.

The LCD screen displays a list of accounts registered on the phone.



2. Press the **All On** soft key to activate DND for all accounts.
3. Press the **Save** soft key to accept the change.

The **DND** icon appears on the status bar and all line icons change to **⊖**.

Incoming calls will be rejected automatically, and the LCD screen will prompt "**n New Missed Call(s)**" ("n" indicates the number of missed calls. e.g., 1 New Missed Call(s)).



To configure the DND authorized numbers via web user interface:

1. Click on **Features->Forward & DND**.
2. Select **Enabled** from the pull-down list of **DND Emergency**.
3. Enter the numbers in the **DND Authorized Numbers** field.

For multiple numbers, enter a comma between every two numbers.

The screenshot shows the Yealink T236 web interface with the 'Features' tab selected. The 'Forward' section is expanded, showing various forwarding options. The 'DND' section is also visible, with the 'DND Emergency' dropdown menu set to 'Enabled' and the 'DND Authorized Numbers' field containing '1003,1004'. A red box highlights these two fields. A 'NOTE' panel on the right provides information about Call Forward and DND modes.

4. Click **Confirm** to accept the change.

When DND is enabled on the phone, the phone can still receive incoming calls from the numbers specified in the **DND Authorized Numbers** field.

Note DND authorized number is configurable via web user interface only.

Call Forward

You can configure your phone to forward incoming calls to another party through static forwarding. You can also forward calls while your phone is ringing; refer to [Dynamic Forwarding](#).

Static Forwarding

Three types of static forwarding:

- **Always Forward:** Incoming calls are immediately forwarded.
- **Busy Forward:** Incoming calls are immediately forwarded if the phone is busy.
- **No Answer Forward:** Incoming calls are forwarded if not answered after a period of time.

You can enable/disable call forward for the phone system, or you can customize call forward for each or all accounts. Two call forward modes:

- **Phone** (default): Call forward is effective for the phone system.
- **Custom**: Call forward can be configured for each or all accounts.

To configure the call forward mode via web user interface:

1. Click on **Features->Forward & DND**.
2. In the **Forward** block, mark the desired radio box in the **Mode** field.

The screenshot shows the Yealink T236 web interface. The 'Features' tab is active, and the 'Forward & DND' section is expanded. The 'Forward' block contains the following settings:

- Forward Emergency: Disabled
- Forward Authorized Numbers: [Empty]
- Mode**: Phone Custom
- Account: 1002
- Always Forward**: On Off
- Target: [Empty]
- On Code: [Empty]
- Off Code: [Empty]
- Busy Forward**: On Off
- Target: [Empty]
- On Code: [Empty]
- Off Code: [Empty]
- No Answer Forward**: On Off
- After Ring Time(0~120s): 12
- Target: [Empty]
- On Code: [Empty]
- Off Code: [Empty]
- DND**: On Off
- DND Emergency: Enabled
- DND Authorized Numbers: 1003,1004

A 'NOTE' box on the right side of the page provides additional information:

Call Forward
It allows users to redirect an incoming call to a third party.

Call Forward Mode
Phone: Call forward feature is effective for the IP phone.
Custom: Call forward feature can be configured for each or all accounts.

Do Not Disturb (DND)
It allows IP phones to ignore incoming calls.

DND Mode
Phone: DND feature is effective for the IP phone.
Custom: DND feature can be configured for each or all accounts.

You can click here to get more guides.



3. Click **Confirm** to accept the change.

Note

Call forward mode is configurable via web user interface only.

To enable call forward in phone mode:

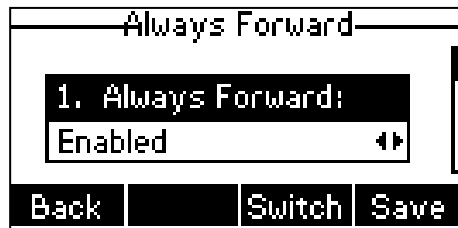

1. Press **Menu->Features->Call Forward**.
2. Press or to select the desired forwarding type, and then press the **Enter** soft key.
3. Depending on your selection:
 - a) If you select **Always Forward**:

- 1) Press  or , or the **Switch** soft key to select **Enabled** from the **Always Forward** field.



- 2) Enter the destination number you want to forward all incoming calls to in the **Forward to** field.
- 3) (Optional.) Enter the always forward on code or off code respectively in the **On Code** or **Off Code** field.

b) If you select **Busy Forward**:

- 1) Press  or , or the **Switch** soft key to select **Enabled** from the **Busy Forward** field.

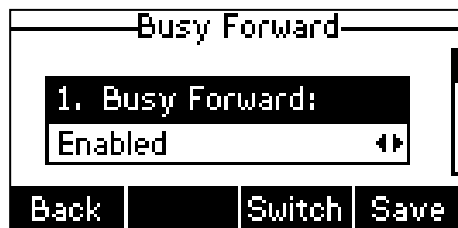



- 2) Enter the destination number you want to forward incoming calls to when the phone is busy in the **Forward to** field.
- 3) (Optional.) Enter the busy forward on code or off code respectively in the **On Code** or **Off Code** field.

c) If you select **No Answer Forward**:

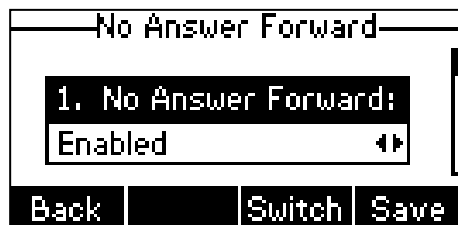
- 1) Press  or , or the **Switch** soft key to select **Enabled** from the **No Answer Forward** field.





- 2) Enter the destination number you want to forward unanswered incoming calls to in the **Forward to** field.
- 3) Press  or , or the **Switch** soft key to select the ring time to wait before forwarding from the **After Ring Time** field.





The default ring time is 12 seconds.

- 4) (Optional.) Enter the no answer forward on code or off code respectively in the **On Code** or **Off Code** field.
4. Press the **Save** soft key to accept the change or the **Back** soft key to cancel.
The  icon on the status bar indicates that the call forward is enabled.

To enable call forward in custom mode:

1. Press **Menu->Features->Call Forward**.
2. Press  or  to select the desired account, and then press the **Enter** soft key.



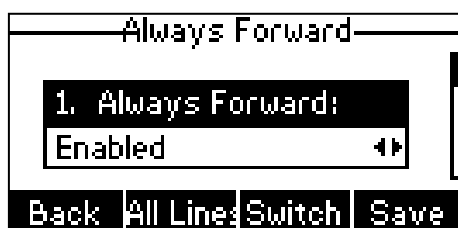

3. Press  or  to select the desired forwarding type, and then press the **Enter** soft key.
4. Depending on your selection:
 - a) If you select **Always Forward**, you can enable it for a specific account.
 - 1) Press  or , or the **Switch** soft key to select **Enabled** from the **Always Forward** field.





- 2) Enter the destination number you want to forward all incoming calls to in the **Forward to** field.
- 3) (Optional.) Enter the always forward on code or off code respectively in the **On Code** or **Off Code** field.

You can also enable always forward for all accounts. After always forward was enabled for a specific account, do the following:

- 1) Press  or  to highlight the **Always Forward** field.
- 2) Press the **All Lines** soft key.

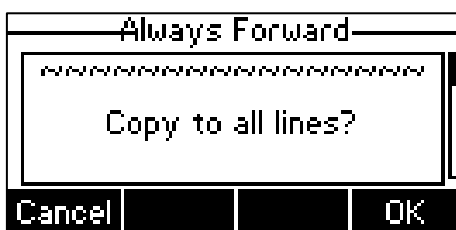
The LCD screen prompts “Copy to all lines?”.



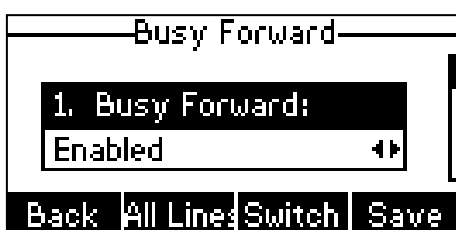

- 3) Press the **OK** soft key to accept the change or the **Cancel** soft key to cancel.
- b) If you select **Busy Forward**, you can enable it for a specific account.
- 1) Press  or , or the **Switch** soft key to select **Enabled** from the **Busy Forward** field.



- 2) Enter the destination number you want to forward all incoming calls to when the phone is busy in the **Forward to** field.
- 3) (Optional.) Enter the busy forward on code or off code respectively in the **On Code** or **Off Code** field.

You can also enable busy forward for all accounts. After busy forward was enabled for a specific account, do the following:

- 1) Press  or  to highlight the **Busy Forward** field.
- 2) Press the **All Lines** soft key.

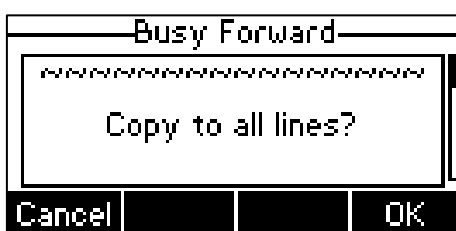

The LCD screen prompts “Copy to all lines?”.

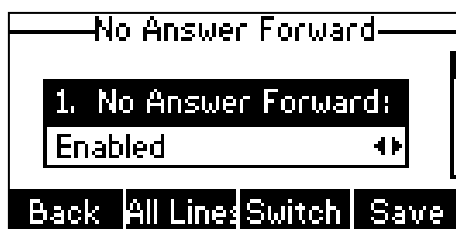

- 3) Press the **OK** soft key to accept the change or the **Cancel** soft key to cancel.
- c) If you select **No Answer Forward**, you can enable it for a specific account.

- 1) Press  or , or the **Switch** soft key to select **Enabled** from the **No Answer Forward** field.





- 2) Enter the destination number you want to forward all unanswered incoming calls to in the **Forward to** field.
- 3) Press  or , or the **Switch** soft key to select the ring time to wait before forwarding from the **After Ring Time** field.

The default ring time is 12 seconds.

- 4) (Optional.) Enter the no answer forward on code or off code respectively in the **On Code** or **Off Code** field.



You can also enable no answer forward for all accounts. After no answer forward was enabled for a specific account, do the following:

- 1) Press  or  to highlight the **No Answer Forward** field.
- 2) Press the **All Lines** soft key.

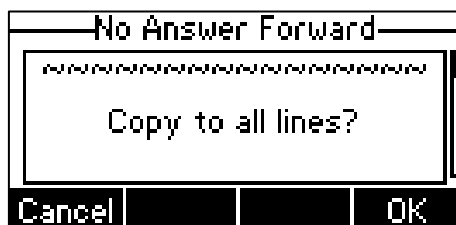
The LCD screen prompts "Copy to all lines?".



- 3) Press the **OK** soft key to accept the change or the **Cancel** soft key to cancel.
5. Press the **Save** soft key to accept the change or the **Back** soft key to cancel.

If you activate call forward for the default account, the associated line icon will change to , and the  icon will appear on the status bar.

If you activate call forward for the non-default account, only the associated line icon will change to .

Call forward is configurable via web user interface at the path **Features->Forward & DND**.

Note

You can also enter the SIP URI or IP address in the **Forward to** field. For more information on using the SIP URI or IP address, refer to [Placing Calls](#) on page 88.

Call forward is local to the phone, and may be overridden by the server settings. Call forward on code or off code may be different between servers. For more information, contact your system administrator.

To configure the forward authorized numbers via web user interface:

1. Click on **Features->Forward & DND**.
2. Select **Enabled** from the pull-down list of **Forward Emergency**.
3. Enter the numbers in the **Forward Authorized Numbers** field.

For multiple numbers, enter a comma between every two numbers.

The screenshot shows the Yealink T236 web interface. The 'Features' tab is selected, and the 'Forward&DND' section is active. The 'Forward' configuration is highlighted with a red box, showing 'Forward Emergency' set to 'Enabled' and 'Forward Authorized Numbers' set to '1058,1059'. Below this, there are sections for 'Mode' (Phone selected), 'Account' (1002), 'Always Forward' (Off selected), 'Busy Forward' (Off selected), and 'No Answer Forward' (Off selected). Each of these sections has fields for 'Target', 'On Code', and 'Off Code'. At the bottom, the 'DND' section shows 'DND Emergency' set to 'Enabled' and 'DND Authorized Numbers' set to '1003,1004'. A 'NOTE' sidebar on the right provides details about 'Call Forward' and 'DND Mode'.





4. Click **Confirm** to accept the change.

When call forward is enabled on the phone, the phone cannot forward incoming calls from the numbers specified in the **Forward Authorized Numbers** field.







Note Forward authorized number is configurable via web user interface only.

To disable call forward in phone mode:

Do one of the following:

- Press  when the phone is idle.
- Press **Menu->Features->Call Forward**.
Press  or  to select the desired forwarding type and then press the **Enter** soft key.
Press  or , or the **Switch** soft key to select **Disabled** to disable the call forward.
Press the **Save** soft key to accept the change.

To disable call forward in custom mode for a specific account:



1. Press **Menu->Features->Call Forward** or press  when the phone is idle.
2. Press  or  to select the desired account and then press the **Enter** soft key.
3. Press  or  to select the desired forwarding type and then press the **Enter** soft key.
4. Press  or , or the **Switch** soft key to select **Disabled** to disable the call forward.
5. Press the **Save** soft key to accept the change.

Dynamic Forwarding

To forward an incoming call to another party:

1. When the phone is ringing, press the **FWD** soft key.
2. Enter the number you want to forward the incoming call to.



3. Press , , or the **Send** soft key.
The LCD screen prompts a call forward message.

Note



When the phone forwards a call, a prompt window will pop up by default, if you want to disable the feature, contact your system administrator for more information.

Call Transfer







You can transfer a call to another party in one of three ways:

- **Blind Transfer:** Transfer a call directly to another party without consulting.
- **Semi-Attended Transfer:** Transfer a call when the target phone is ringing.
- **Attended Transfer:** Transfer a call with prior consulting.







To perform a blind transfer:

1. Press  or the **Tran** soft key during a call.
2. Enter the number you want to transfer the call to.
3. Press  or the **Tran** soft key to complete call transfer.
Then the call is connected to the number to which you are transferring.

To perform a semi-attended transfer:

1. Press  or the **Tran** soft key during a call.
2. Do one of the following:
 - Enter the number you want to transfer the call to.
 - Press the **Dir** soft key, and then select **Local Directory**. Select the desired group and search for the contact (Directory should be configured in advance. Refer to [Directory](#) on page 46 for more information).
 - Press the **Dir** soft key, and then select **History**. Select the desired list and then press  or  to select the entry (Directory should be configured in advance. Refer to [Directory](#) on page 46 for more information).
 - Press the **Dir** soft key, and then select **Remote Phone Book**. Select the desired group and search for the contact (Directory should be configured in advance. Refer to [Directory](#) on page 46 and [Remote Phone Book](#) on page 59 for more information).
3. Press  or  to dial out.
4. Press  or the **Tran** soft key to complete the transfer when receiving ringback.

To perform an attended transfer:

1. Press  or the **Tran** soft key during a call.
2. Do one of the following:
 - Enter the number you want to transfer the call to.
 - Press the **Dir** soft key, and then select **Local Directory**. Select the desired group and search for the contact (Directory should be configured in advance. Refer to [Directory](#) on page 46 for more information).
 - Press the **Dir** soft key, and then select **History**. Select the desired list and then press  or  to select the entry (Directory should be configured in advance. Refer to [Directory](#) on page 46 for more information).
 - Press the **Dir** soft key, and then select **Remote Phone Book**. Select the desired group and search for the contact (Directory should be configured in advance. Refer to [Directory](#) on page 46 and [Remote Phone Book](#) on page 59 for more information).
3. Press  or  to dial out.
4. After the party answers the call, press  or the **Tran** soft key to complete the transfer.

If you are using a handset, the transfer can be completed by hanging up the handset.

You can cancel the transfer before the call is connected by pressing the **Cancel** soft key.

Call Waiting

You can enable or disable call waiting on the phone. If call waiting is enabled, you can receive another call while there is already an active call on the phone. Otherwise, another incoming call is automatically rejected by the phone with a busy message when there is an active call on the phone. You can also enable or disable the phone to play a warning tone when receiving another call.

To configure call waiting via phone user interface:

1. Press **Menu->Features->Call Waiting**.
2. Press ◀ or ▶, or the **Switch** soft key to select **Enabled** from the **Call Waiting** field.

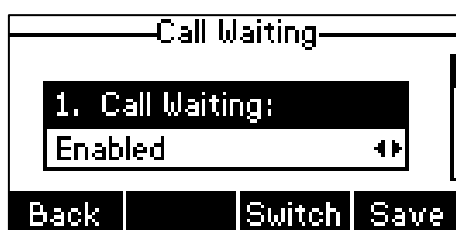

3. Press ◀ or ▶, or the **Switch** soft key to select **Enabled** from the **Play Tone** field.
4. (Optional.) Enter the call waiting on code or off code respectively in the **On Code** or **Off Code** field.
5. Press the **Save** soft key to accept the change or the **Back** soft key to cancel.

Call waiting is configurable via web user interface at the path **Features->General Information**.

Conference

You can create a conference with other two parties using the phone's local conference. You can create a conference between an active call and a call on hold by pressing the **Conf** soft key. The SIP-T23P/G IP phone also supports network conference.

Note

Network conference is not available on all servers. For more information, contact your system administrator.

Local Conference

The SIP-T23P/G IP phone supports up to 3 parties (including yourself) in a conference call. This is the default method of conference called Local Conference.

To set up a local conference call:

1. Place a call to the first party.
2. When the first party answers the call, press the **Conf** soft key to place a new call.
The active call is placed on hold.
3. Enter the number of the second party and then press **OK** , **#END** , or the **Send** soft key.
4. When the second party answers the call, press the **Conf** soft key again to join all parties in the conference.

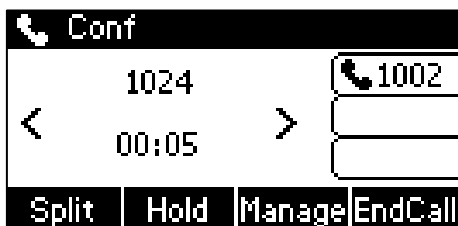

You can press **◀** or **▶** to see all parties in the conference.

To join two calls in a conference:

1. Place two calls using two different accounts on the phone (for example, place the first call using account 1, and then place the second call using account 2).
2. Press **▲** or **▼** to select the call for conference and ensure that the call is active (for example, select the call on account 1).
3. Press the **Conf** soft key to join the two calls in the conference on the selected account.

During the conference call, you can do the following actions:

- Press the **Hold** soft key to place the conference on hold.
- Press the **Split** soft key to split the conference call into two individual calls on hold.
- Press the **Manage** soft key, and then press **◀** or **▶** to select the desired party:
 - Press the **FarMute** soft key to mute the party. The muted party can hear everyone, but no one can hear the muted party.
 - Press the **Remove** soft key to remove the party from the conference call.
 - Press the **New Call** soft key to place a new call.
 - Press the **Back** soft key to return to the previous screen.
- Press **⊗** to mute the conference call, all other participants can hear each other, but they cannot hear you.
- Press the **EndCall** soft key to drop the conference call.

Network Conference

You can use network conference feature on the SIP-T23P/G IP phone to conduct a conference with multiple participants.

This feature allows you to perform the following:

- Join two calls together into a conference call.
- Invite another party into an active conference call.

To use this feature, contact your system administrator for the network conference URI in advance.

To configure network conference via web user interface:

1. Click on **Account->Advanced**.
2. Select the desired account from the pull-down list of **Account**.
3. Select **Network Conference** from the pull-down list of **Conference Type**.
4. Enter the conference URI (e.g., conference@example.com) in the **Conference URI** field.



The screenshot shows the Yealink T236 web interface. The 'Account' tab is active, and the 'Advanced' sub-tab is selected. The 'Conference Type' dropdown menu is set to 'Network Conference', and the 'Conference URI' field contains 'conference@example.com'. A red box highlights these two fields. The page includes a sidebar with navigation options (Register, Basic, Codec, Advanced), a top navigation bar (Status, Account, Network, DSSKey, Features, Settings, Directory, Security), and a right-hand 'NOTE' section with information about DTMF, Session Timer, Busy Lamp Field/BLF List, Shared Call Appearance (SCA)/ Bridge Line Appearance (BLA), and Network Conference.

5. Click **Confirm** to accept the change.

To set up a network conference call:

1. Place a call to the first party.
2. Press the **Conf** soft key to place a new call.



The active call is placed on hold.

3. Enter the number of the second party and then press  ,  , or the **Send** soft

key.

4. When the second party answers the call, press the **Conf** soft key to add the second party to the conference.
5. Press the **Conf** soft key to place a new call.

The conference is placed on hold.

6. Enter the number of the new party and then press  ,  , or the **Send** soft key.
7. When the new party answers the call, press the **Conf** soft key to add the new party to the conference.
8. Repeat steps 5 to 7 until you have added all intended parties.

The procedures to set up a network conference call on specific servers may be different from introduced above. Contact your system administrator for more information.





Call Park

You can use call park feature to place a call on hold, and then retrieve the call from another phone in the system (for example, a phone in another office or conference room). You can park an active call by pressing the call park key on the phone. If the call is parked successfully, the response is either a voice prompt confirming that the call was parked, or a visible prompt on the LCD screen.



Note

Call park is not available on all servers. Contact your system administrator for more information.

To configure a call park key via phone user interface:

1. Press **Menu->Features->DSS Keys**.
2. Select the desired DSS key.
3. Press  or  , or the **Switch** soft key to select **Key Event** from the **Type** field.
4. Press  or  , or the **Switch** soft key to select **Call Park** from the **Key Type** field.



5. Press  or  , or the **Switch** soft key to select the desired line from the **Account ID** field.
6. (Optional.) Enter the string that will appear on the LCD screen in the **Label** field.
7. Enter the call park code in the **Value** field.
8. Press the **Save** soft key to accept the change or the **Back** soft key to cancel.

Call park key is configurable via web user interface at the path **DSSKey->Line Key**.

To use call park:

1. User on phone A places a call to phone B.
2. User on phone A wants to take the call in a conference room for privacy, and so presses the call park key on phone A.
3. User on phone A walks to an available conference room where the phone is designated as phone C. The user dials the call park retrieve code to retrieve the parked call.

The system establishes call between phone C and B.

Note

The call park code and call park retrieve code are predefined on the system server. Contact your system administrator for more information.

If the parked call is not retrieved within a period of time assigned by the system, the phone performing call park will receive call back.

Call Pickup

You can use call pickup to answer someone else's incoming call on your phone. The SIP-T23P/G IP phone supports directed call pickup and group call pickup. Directed call pickup is used for picking up a call that is ringing at a target phone number. Group call pickup is used for picking up a call that is ringing at any phone number in a certain group. The pickup group should be predefined, contact your system administrator for more information.

You can pick up an incoming call by using the **DPickup/GPickup** soft key. To use call pickup, you need to configure the call pickup code beforehand on a global or per-line basis via web user interface.

Note

If there are many incoming calls at the same time, pressing the **GPickup** soft key on the phone will pick up the call that rings first.

Directed Call Pickup

To enable directed call pickup and configure the directed call pickup code on a global basis via web user interface:

1. Click on **Features->Call Pickup**.
2. Select **Enabled** from the pull-down list of **Directed Call Pickup**.

3. Enter the directed call pickup code in the **Directed Call Pickup Code** field.

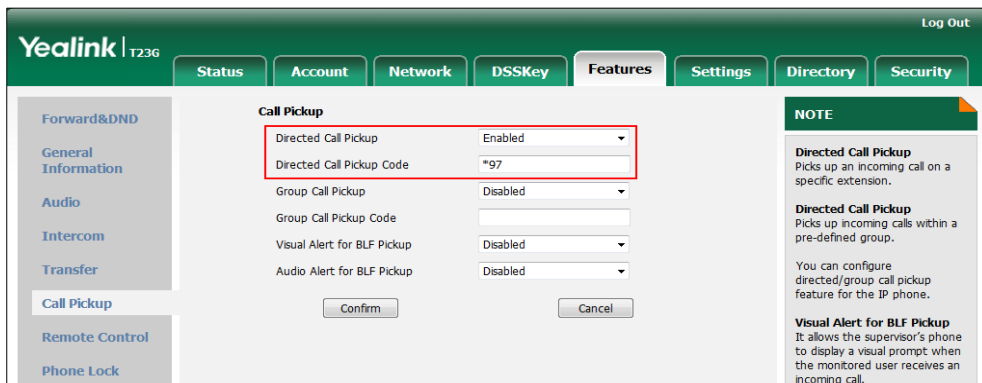

4. Click **Confirm** to accept the change.

To configure the directed call pickup code on a per-line basis via web user interface:

1. Click on **Account->Advanced**.
2. Select the desired account from the pull-down list of **Account**.
3. Enter the directed call pickup code in the **Directed Call Pickup Code** field.

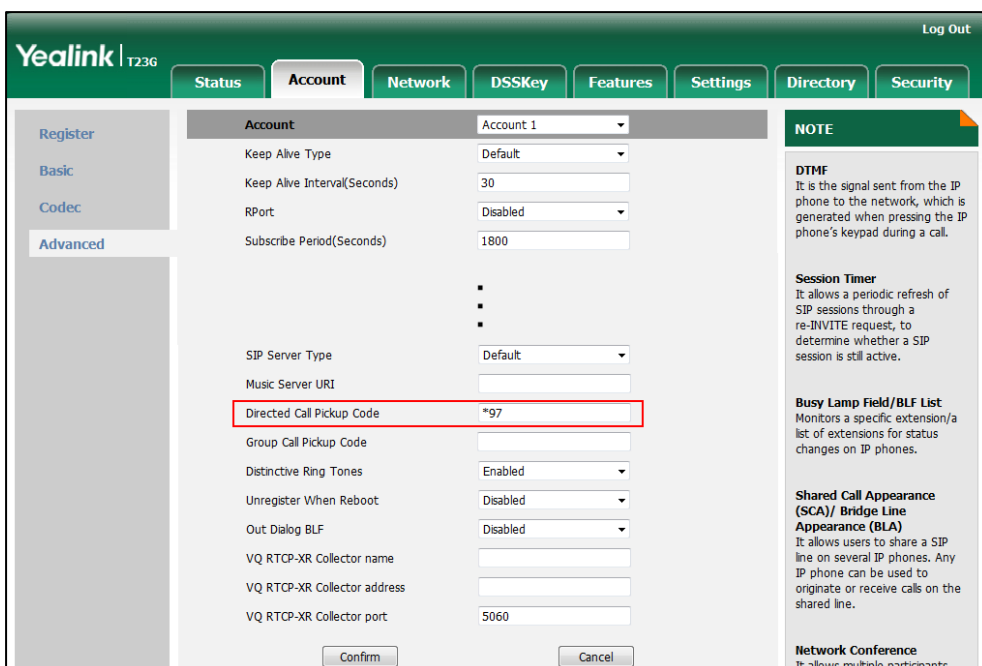

4. Click **Confirm** to accept the change.

To pick up a call directly:

1. Pick up the handset, press the Speakerphone key or press the line key (You may need to press the **More** soft key to see the **DPickup** soft key).

The **DPickup** soft key appears on the LCD screen.



2. Press the **DPickup** soft key on your phone when the target phone receives an incoming call.
3. Enter the phone number which is receiving an incoming call.
4. Press the **DPickup** soft key again.

The call is answered on your phone.

You can also configure a DSS key as a direct pickup key via phone user interface or web user interface. Once configured, you can pick up a call by pressing the directed pickup key directly.

Group Call Pickup

To enable group call pickup and configure the group call pickup code on a global basis via web user interface:

1. Click on **Features->Call Pickup**.
2. Select **Enabled** from the pull-down list of **Group Call Pickup**.
3. Enter the group call pickup code in the **Group Call Pickup Code** field.

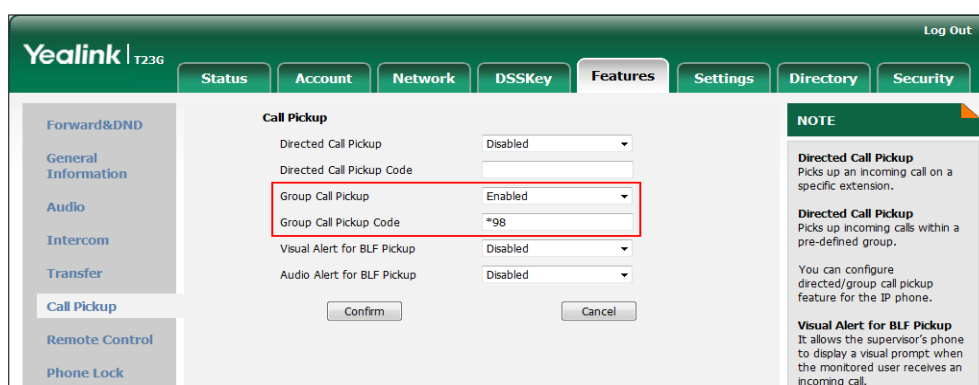

4. Click **Confirm** to accept the change.

To configure the group call pickup code on a per-line basis via web user interface:

1. Click on **Account->Advanced**.
2. Select the desired account from the pull-down list of **Account**.

- Enter the group call pickup code in the **Group Call Pickup Code** field.

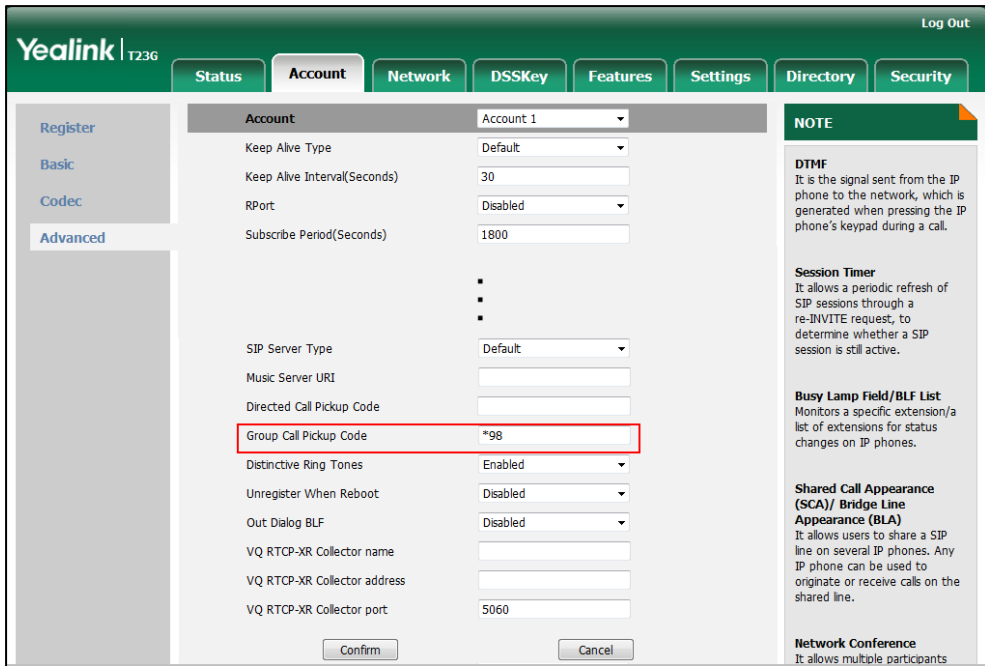

- Click **Confirm** to accept the change.

To pick up a call in the group:

- Pick up the handset, press the Speakerphone key or press the line key.
The **GPickup** soft key appears on the LCD screen.

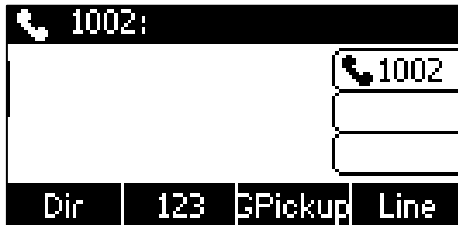

- Press the **GPickup** soft key on your phone when a phone in the group receives an incoming call.
The call is answered on your phone.

You can also configure a DSS key as group pickup key via phone user interface or web user interface. Once configured, you can pick up a call by pressing the group pickup key directly.

Note

The directed call pickup code and group call pickup code are predefined on the system server. Contact your system administrator for more information.

The call pickup code configured on a per-line basis takes precedence over that configured on a global basis.

Anonymous Call

You can use anonymous call to block your identify and phone number from appearing to the called party when you call someone. For example, you want to call to consult some services, but don't want to be harassed. Anonymous call is configurable on a per-line basis. You can also configure the phone to send anonymous call on/off code to the server to activate/deactivate anonymous call on the server side.

Note

Anonymous call is not available on all servers. Contact your system administrator for the anonymous call on code and off code.

To configure anonymous call via phone user interface:

1. Press **Menu->Features->Anonymous Call**.
2. Press **◀** or **▶** , or the **Switch** soft key to select the desired line from the **Line ID** field.
3. Press **◀** or **▶** , or the **Switch** soft key to select **Enabled** from the **Local Anonymous** field.

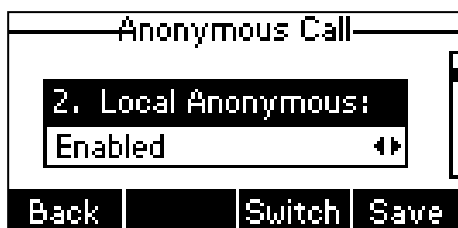

4. (Optional.) Press **◀** or **▶** , or the **Switch** soft key to select the desired value from the **Send Anony Code** field.
The phone will send the configured on code or off code depending on your selection when you enable or disable anonymous call feature on the phone.
5. (Optional.) Enter the anonymous call on code in the **On Code** field.
6. (Optional.) Enter the anonymous call off code in the **Off Code** field.
7. Press the **Save** soft key to accept the change or the **Back** soft key to cancel.

Anonymous call is configurable via web user interface at the path **Account->Basic**.

To place an anonymous call:

1. Using the specific line on the phone to place a call to phone B.

The LCD screen of phone B prompts an incoming call from anonymity.

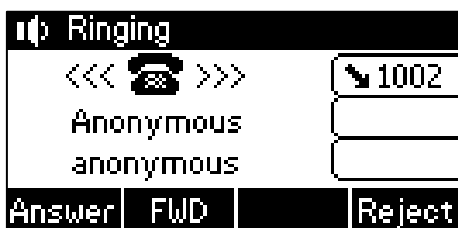

Anonymous Call Rejection

You can use anonymous call rejection to reject incoming calls from anonymous callers. Anonymous call rejection automatically rejects incoming calls from callers who deliberately block their identities and numbers from being displayed. Anonymous call rejection is configurable on a per-line basis. You can also configure the phone to send anonymous call rejection on/off code to the server to activate/deactivate anonymous call rejection on the server side.

To configure anonymous call rejection via phone user interface:

1. Press **Menu->Features->Anonymous Call**.
2. Press **◀** or **▶**, or the **Switch** soft key to select the desired line from the **Line ID** field.
3. Press **▲** or **▼** to scroll to the **Anonymous Rejection** field.
4. Press **◀** or **▶**, or the **Switch** soft key to select **Enabled** from the **Anonymous Rejection** field.

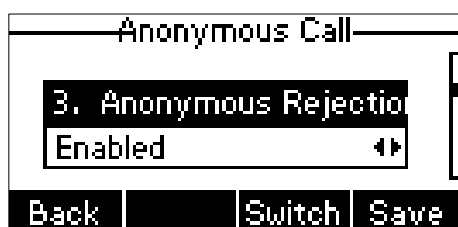

5. (Optional.) Press **◀** or **▶**, or the **Switch** soft key to select the desired value from the **Send Rejection Code** field.

The phone will send the configured on code or off code depending on your selection when you enable or disable anonymous call rejection feature on the phone.

6. (Optional.) Enter the anonymous call rejection on code in the **Reject On Code** field.
7. (Optional.) Enter the anonymous call rejection off code in the **Reject Off Code** field.
8. Press the **Save** soft key to accept the change or the **Back** soft key to cancel.

Anonymous call rejection is configurable via web user interface at the path **Account->Basic**.

Advanced Phone Features

This chapter provides operating instructions for the advanced features of the SIP-T23P/G IP phone. Topics include:

- [Busy Lamp Field \(BLF\)](#)
- [BLF List](#)
- [Call Recording](#)
- [Hot Desking](#)
- [Intercom](#)
- [Multicast Paging](#)
- [Music on Hold](#)
- [Automatic Call Distribution \(ACD\)](#)
- [Shared Call Appearance \(SCA\)](#)
- [Bridged Line Appearance \(BLA\)](#)
- [Messages](#)

If you require additional information or assistance with your new phone, contact your system administrator.



Busy Lamp Field (BLF)

You can use BLF to monitor a specific line for status changes on the phone. For example, you can configure a BLF key on the phone to monitor the status of a friend's line (busy or idle). The BLF key LED illuminates solid red when the friend's line is in use. For more information on BLF key LED indicators, refer to [LED Instructions](#) on page 14.



You can press a BLF key to dial out the monitored phone number when the monitored line is idle. You can receive a visual or/and an audio alert (if enabled), and also pick up calls that are received on the monitored line. For more information, contact your system administrator.

To configure a BLF key via phone user interface:

1. Press **Menu->Features->DSS Keys**.
2. Select the desired DSS key.

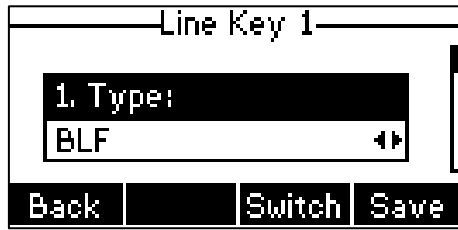
- Press  or , or the **Switch** soft key to select **BLF** from the **Type** field.



- Press  or , or the **Switch** soft key to select the desired line from the **Account ID** field.
- (Optional.) Enter the string that will appear on the LCD screen in the **Label** field.
- Enter the phone number or extension you want to monitor in the **Value** field.
- (Optional.) Enter the directed call pickup code in the **Extension** field.
- Press the **Save** soft key to accept the change or the **Back** soft key to cancel.

BLF key is configurable via web user interface at the path **DSSKey->Line Key**.

You can enable audio alert feature for BLF pickup on the phone. This allows the monitoring phone to play a warning tone when the monitored line receives an incoming call. You can also enable visual alert feature for BLF pickup on the phone. This allows the LCD screen of the monitoring phone to display the caller ID when the monitored line receives an incoming call.

To enable visual and audio alert features via web user interface:

- Click on **Features->Call Pickup**.
- Select **Enabled** from the pull-down list of **Visual Alert for BLF Pickup**.
- Select **Enabled** from the pull-down list of **Audio Alert for BLF Pickup**.

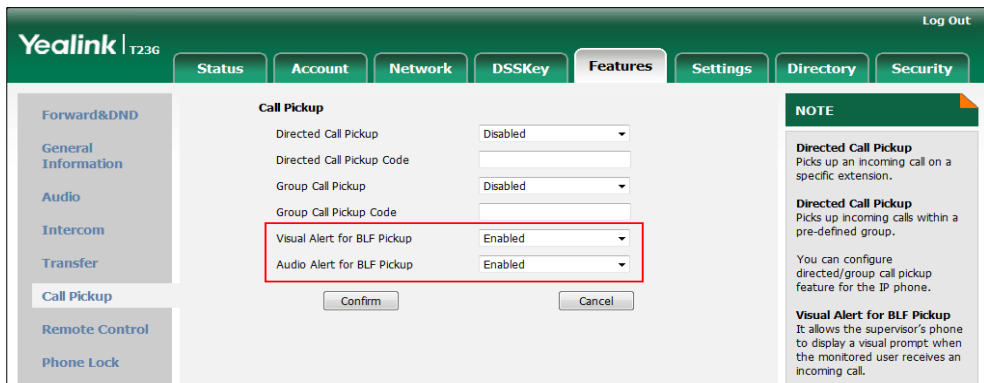

- Click **Confirm** to accept the change.

Note Visual and audio alert features are configurable via web user interface only.

When the monitored line receives an incoming call, the following occurs on your phone:

- The phone plays a warning tone (if enabled).
- The BLF key LED flashes red.
- The caller ID appears on the LCD screen (if enabled).

In the following figure, the LCD screen shows an incoming call from 2500 on the monitored line.



Note

If your phone is locked and the type of the phone lock is configured as **Function Keys** or **All Keys**, you cannot use the **DPickup**, **Send**, **NewCall** and **Cancel** soft keys until unlocked. For more information, refer to [Phone Lock](#) on page 40.

When there is an active call on the IP phone, you can transfer the active call to the monitored phone number directly by pressing the BLF key. The phone handles the active call differently depending on the transfer mode via DSS key. For more information on performing call transfer, refer to [Transfer](#) in DSS Keys section on page 71.

BLF List

You can use the BLF List feature to monitor a list of users defined by your system administrator. For example, your system administrator enables BLF List, and creates a BLF List URI (e.g., BLFList@example.com) including a list of user1, user2 on the server. The BLF List keys on the IP phone can present the status of user1 and user2. The key LEDs illuminate either flashing or solid depending on the status of those users. For more BLF List key LED indicators, refer to [LED Instructions](#) on page 14.

You can use the BLF List keys in the following ways:

- When the monitored user is idle, press the BLF list key to dial out the phone number.
- When there is already an active call on the IP phone, you can transfer the active call to the monitored user by pressing the BLF List key. The phone handles the active call differently depending on the transfer mode on DSS key. For more information on the transfer mode on DSS key, refer to [Transfer](#) in DSS Keys section on page 71.
- When the monitored user receives an incoming call, press the BLF list key to pick up the call directly. Before picking up an incoming call, ensure that the BLF List Pickup Code has been configured in advance. If the code is not configured, the phone will place a call to the monitored user instead of picking up the incoming call of the

monitored user when you press the BLF List key.

- When there is a conversation on the monitored user, press the BLF list key to barge in and set up a conference call. Before barging in an active call, ensure that the BLF List Barge In Code has been configured in advance. If the code is not configured, the phone will place a call to the monitored user instead of barging in an active call of the monitored user when you press the BLF List key.
- When a call is being parked against the monitored phone, press the BLF List key to retrieve the parked call from the monitored user. Before retrieving the parked call, ensure that the BLF List Retrieve Call Parked Code has been configured in advance. If the code is not configured, the phone will place a call to the monitored user instead of retrieving the parked call when you press the BLF List key.

To configure BLF List settings via web user interface:

1. Click on **Account->Advanced**.
2. Select the desired account from the pull-down list of **Account**.
3. Enter the BLF List URI in the **BLF List URI** field.
4. (Optional.) Enter the directed pickup code in the **BLF List Pickup Code** field.
5. (Optional.) Enter the barge-in code in the **BLF List Barge In Code** field.
6. (Optional.) Enter the call park retrieve code in the **BLF List Retrieve Call Parked Code** field.

The screenshot displays the Yealink T236 web interface for configuring account settings. The 'Account' tab is active, and the 'Advanced' sub-tab is selected. A red box highlights the BLF List configuration fields:

- BLF List URI:** 4609@pbx.yealink.com
- BLF List Pickup Code:** *97
- BLF List Barge In Code:** *33
- BLF List Retrieve Call Parked Code:** *88

Other visible settings include:

- Keep Alive Type: Default
- Keep Alive Interval(Seconds): 30
- RPort: Disabled
- Subscribe Period(Seconds): 1800
- PTime(ms): 20
- Shared Line: Disabled
- Dialog Info Call Pickup: Disabled
- VQ RTCP-XR Collector name: (empty)
- VQ RTCP-XR Collector address: (empty)
- VQ RTCP-XR Collector port: 5060

A 'NOTE' section on the right provides additional information:

- DTMF:** It is the signal sent from the IP phone to the network, which is generated when pressing the IP phone's keypad during a call.
- Session Timer:** It allows a periodic refresh of SIP sessions through a re-INVITE request, to determine whether a SIP session is still active.
- Busy Lamp Field/BLF List:** Monitors a specific extension/a list of extensions for status changes on IP phones.
- Shared Call Appearance (SCA)/ Bridge Line Appearance (BLA):** It allows users to share a SIP line on several IP phones. Any IP phone can be used to originate or receive calls on the shared line.
- Network Conference:** It allows multiple participants.

7. Click **Confirm** to accept the change.

Note

For more information on BLF List URI/BLF List Pickup Code/BLF List Barge In Code/BLF List Retrieve Call Parked Code, contact your system administrator.

According to the response message from the server, the IP phone will automatically configure the BLF List keys beginning from the first unused Line key. Once any Line key is seized, the IP phone will skip to configure the next Line key.

You can receive a visual or/and an audio alert (if enabled) on your phone when the monitored user receives an incoming call. For more information, refer to [Busy Lamp Field \(BLF\)](#) on page 121.

Note

The pickup code is used in the following order of preference: BLF List Pickup Code (Account->Advanced)>Directed Call Pickup Code (Account->Advanced)>Directed Call Pickup Code (Features->Call Pickup). If all of them are not configured, pressing the BLF List key will directly call the monitored user when he/she receives an incoming call. For more information about pickup Code, refer to [Call Pickup](#) on page 115.

Call Recording

You can record calls by pressing a record key on the phone. The SIP-T23P/G IP phone supports record and URL record.

Two ways of call recording:

- **Record:** The phone sends SIP INFO message containing a specific header "Record: on/off" to trigger a recording.
- **URL Record:** The phone sends HTTP URL request to trigger a recording. Contact your system administrator for the predefined URL.

Note

Call record is not available on all servers. Contact your system administrator for more information.

To configure a record key via phone user interface:

1. Press **Menu->Features->DSS Keys**.
2. Select the desired DSS key.
3. Press **◀** or **▶**, or the **Switch** soft key to select **Key Event** from the **Type** field.
4. Press **◀** or **▶**, or the **Switch** soft key to select **Record** from the **Key Type** field.

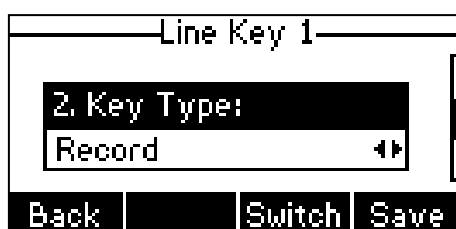

5. (Optional.) Enter the string that will appear on the LCD screen in the **Label** field.
6. Press the **Save** soft key to accept the change or the **Back** soft key to cancel.

To configure a URL record key via phone user interface:

1. Press **Menu->Features->DSS Keys**.
2. Select the desired DSS key.
3. Press ◀ or ▶ , or the **Switch** soft key to select **URL Record** from the **Type** field.

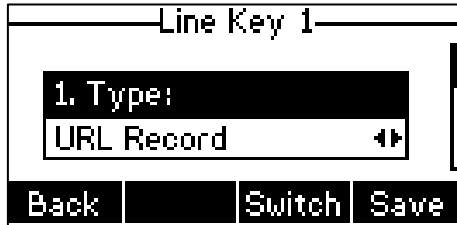

4. (Optional.) Enter the string that will appear on the LCD screen in the **Label** field.
5. Enter the URL (e.g., http://10.1.2.224/phonerecording.cgi) in the **Value** field.
6. Press the **Save** soft key to accept the change or the **Back** soft key to cancel.

Record and URL record keys are configurable via web user interface at the path **DSSKey->Line Key**.

The Record and URL Record keys control the recording function, and are available:

- During an active call
- When calls are on hold or mute
- During a blind or attended transfer
- During a conference call
- When the phone prompts you to answer an incoming call

The Record and URL Record keys are not available when:

- There are no connected calls on your phone
- You place a new call

To record a call:

1. Press the Record or URL Record key during a call.
If the recording starts successfully, the recording icon will appear on the LCD screen and the Record or URL Record key LED will flash green.
2. Press the Record or URL Record key again to stop recording.
The recording icon disappears from the LCD screen and the Record or URL Record key LED goes out.

Recording status indicators you need to know:

Circumstance	Icons on the LCD screen
A recording is started	● appears on the LCD screen

Circumstance	Icons on the LCD screen
A recording cannot be started	⊗ appears for 1 second
A recording cannot be stopped	⊘ appears for 1 second, then goes back
The recording box is full	⊙ appears for 1 second
The call cannot be recorded	⊗ appears for 1 second

You can listen to the recordings stored on your server system. For example, you can dial an access code to listen to the recordings.

Note

The way in which you listen to the recordings may be different depending on the server. Contact your system administrator for more information.

Hot Desking

Hot desking originates from the definition of being the temporary physical occupant of a work station or surface by a particular employee. A primary motivation for hot desking is cost reduction. This feature is regularly used in places where not all the employees are in the office at the same time, or not in the office for very long, which means that actual personal offices would be often vacant, consuming valuable space and resources.

You can use hot desking on the SIP-T23P/G IP phone to log out of the existing accounts and then log into a new account. As a result, many users can share the phone resource at different times. To use this feature, you need to configure a hot desking key in advance.

Note

Hot desking is not available on all servers. Contact your system administrator for more information.

To configure a hot desking key via phone user interface:

1. Press **Menu->Features->DSS Keys**.
2. Select the desired DSS key.
3. Press ◀ or ▶, or the **Switch** soft key to select **Key Event** from the **Type** field.
4. Press ◀ or ▶, or the **Switch** soft key to select **Hot Desking** from the **Key Type** field.

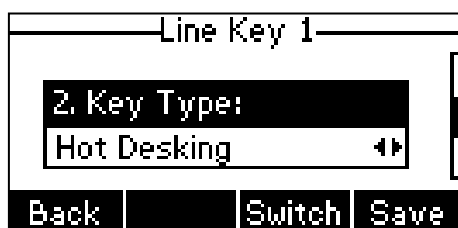

5. (Optional.) Enter the string that will appear on the LCD screen in the **Label** field.
6. Press the **Save** soft key to accept the change or the **Back** soft key to cancel.

Hot desking key is configurable via web user interface at the path **DSSKey->Line Key**.

To use hot desking:

1. Press the hot desking key when the phone is idle.

The LCD screen prompts the following warning:



2. Press the **OK** soft key, registration configurations of all accounts on the phone will be cleared immediately.

The login wizard will be displayed as below:



3. Enter the login information in each field.
4. Press the **Save** soft key to login or the **Cancel** soft key to cancel.

Intercom



Intercom is a useful feature in an office environment to quickly connect with the operator or the secretary. You can press the intercom key to automatically connect with a preconfigured target extension for outgoing intercom calls, and the target extension will automatically answer incoming intercom calls by default.

Note Intercom is not available on all servers. Contact your system administrator for more information.

Outgoing Intercom Calls

To configure an intercom key via phone user interface:

1. Press **Menu->Features->DSS Keys**.

2. Select the desired DSS key.
3. Press  or , or the **Switch** soft key to select **Intercom** from the **Type** field.

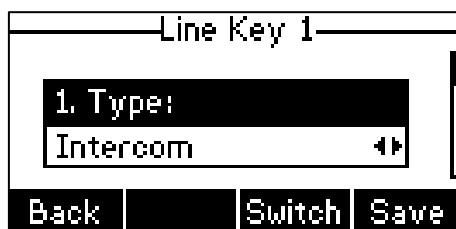

4. Select the desired line from the **Account ID** field.
5. (Optional.) Enter the string that will appear on the LCD screen in the **Label** field.
6. Enter the target extension number in the **Value** field.
7. Press the **Save** soft key to accept the change or the **Back** soft key to cancel.

Intercom key is configurable via web user interface at the path **DSSKey->Line Key**.

Incoming Intercom Calls

The SIP-T23P/G IP phone supports automatically to answer an incoming intercom call by default. The phone automatically plays a warning tone when it receives an incoming intercom call. In addition, you can enable the phone to mute the microphone when it automatically answers an incoming intercom call. You can also enable the phone to automatically answer an incoming intercom call while there is already an active call on the phone. The active call is then placed on hold.

Intercom features you need to know:

Intercom Feature	Description
Accept Intercom	Enable or disable the IP phone to answer an incoming intercom call.
Intercom Mute	Enable or disable the IP phone's microphone for intercom calls.
Intercom Tone	Enable or disable the IP phone to play a warning tone when it receives an incoming intercom call.
Intercom Barge	Enable or disable the IP phone to automatically answer an incoming intercom call while there is already an active call on the phone.

Accept Intercom

You can enable or disable the phone to answer an incoming intercom call. If Accept Intercom is enabled, the phone will automatically answer an incoming intercom call. If Accept Intercom is disabled, the phone will reject incoming intercom calls and send a busy message to the caller. Accept Intercom is enabled by default.

Note

Your administrator can set a period of delay time before the phone automatically answers intercom calls. Contact your system administrator for more information.

Intercom Mute

You can mute or un-mute the phone’s microphone for intercom calls automatically. If Intercom Mute is enabled, the microphone will be muted for intercom calls. If Intercom Mute is disabled, the microphone will work for intercom calls. Intercom Mute is disabled by default.

Intercom Tone

You can enable or disable the phone to play a warning tone when receiving an intercom call. If Intercom Tone is enabled, the phone will play a warning tone before answering the intercom call. If Intercom Tone is disabled, the phone will automatically answer the intercom call without warning. Intercom Tone is enabled by default.

Intercom Barge

You can enable or disable the phone to automatically answer an incoming intercom call while there is already an active call on the phone. If Intercom Barge is enabled, the phone will automatically answer the intercom call and place the active call on hold. If Intercom Barge is disabled, the phone will handle an incoming intercom call like a waiting call. Intercom Barge is disabled by default.

Note

To enable the phone to receive a new incoming call when it has an active call, make sure that call waiting feature is enabled on the phone in advance. For more information, refer to [Call Waiting](#) on page 111.

To configure intercom features via phone user interface:

1. Press **Menu->Features->Intercom**.
2. Make the desired changes.

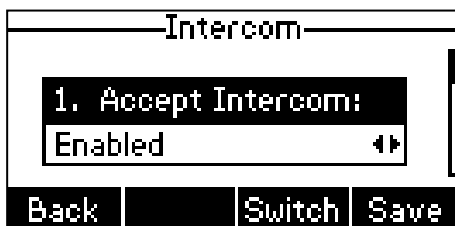

3. Press the **Save** soft key to accept the change or the **Back** soft key to cancel.

These specific parameters are configurable via web user interface at the path **Features->Intercom**.

Using Intercom

To place an intercom call when the target phone is idle:

1. Press the intercom key when the phone is idle.





The called destination plays a warning tone and automatically answers the call in the speakerphone mode by default.
2. To end the intercom call, press the intercom key again or the **EndCall** soft key.

Multicast Paging

You can use multicast paging to quickly and easily broadcast time sensitive announcements to users who are listening to a specific multicast group. You can configure a multicast paging key or the paging list key on the phone, which allows you to send a Real Time Transport Protocol (RTP) stream to the pre-configured multicast address(es) without involving SIP signaling. You can configure the phone to receive an RTP stream from pre-configured multicast listening address(es) without involving SIP signaling. You can specify up to 10 multicast listening addresses.

Sending RTP Stream

To configure a multicast paging key via phone user interface:

1. Press **Menu->Features->DSS Keys**.
2. Select the desired DSS key.
3. Press  or , or the **Switch** soft key to select **Key Event** from the **Type** field.
4. Press  or , or the **Switch** soft key to select **Multicast Paging** from the **Key Type** field.

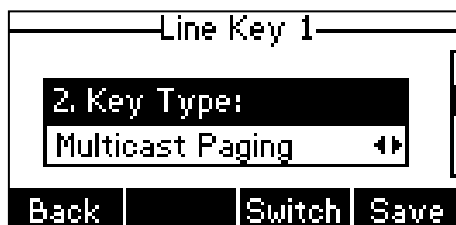





5. (Optional.) Enter the string that will appear on the LCD screen in the **Label** field.
6. Enter the multicast IP address and port number (e.g., 224.5.6.20:10008) in the **Value** field.

The valid multicast IP addresses range from 224.0.0.0 to 239.255.255.255.

7. Press the **Save** soft key to accept the change or the **Back** soft key to cancel.

Multicast paging key is configurable via web user interface at the path **DSSKey->Line Key**.

To configure a paging list key via phone user interface:

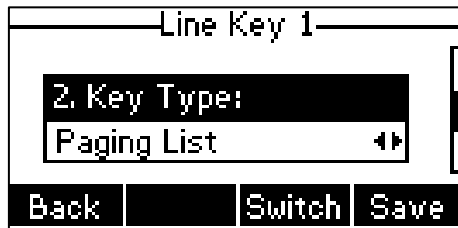

1. Press **Menu->Features->DSS Keys**.
2. Select the desired DSS key.
3. Press  or , or the Switch soft key to select **Key Event** from the **Type** field.
4. Press  or , or the Switch soft key to select **Paging List** from the **Key Type** field.



5. (Optional.) Enter the string that will appear on the LCD screen in the **Label** field.
6. Press the **Save** soft key to accept the change or the **Back** soft key to cancel.

Paging list key is configurable via web user interface at the path **DSSKey->Line Key**.

To configure paging list via phone user interface:

1. Press the paging list key when the phone is idle.
2. Press  or  to select a desired paging group.
The default tag is Empty if it is not configured before.

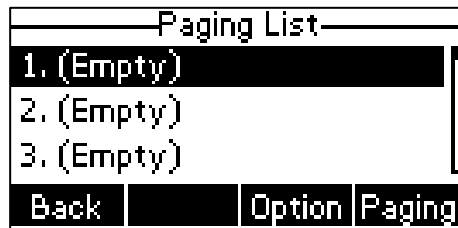

3. Press the **Option** soft key and then press the **Edit** soft key.
4. Enter the multicast IP address and port number (e.g., 224.5.6.20:10008) in the **Address** field.



The valid multicast IP addresses range from 224.0.0.0 to 239.255.255.255.



5. Enter the group name in the **Label** field.
6. Press the **Save** soft key to accept the change.
7. Repeat steps 2 to 6, you can add more paging groups.

Paging list is configurable via web user interface at the path: **Directory->Multicast IP**.

To delete a paging group via phone user interface:

1. Press the paging list key when the phone is idle.
2. Press  or  to select a desired group.
3. Press the **Option** soft key and then select **Delete**.

The LCD screen prompts "Delete selected paging group?".

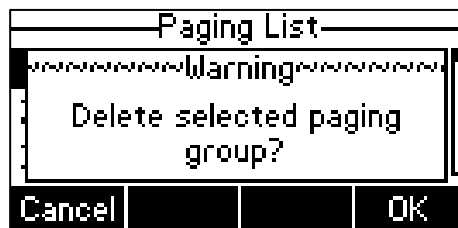

4. Press the **OK** soft key to accept the change or the **Cancel** soft key to cancel.

If you want to delete all paging groups, you can press the **Del All** soft key.

You can also configure the phone to use a default codec for sending multicast RTP stream via web user interface.

To configure a default codec for multicast paging via web user interface:

1. Click on **Features->General Information**.

- Select the desired codec from the pull-down list of **Multicast Codec**.

The default codec is G722.

The screenshot shows the Yealink T23G web interface. The 'Features' tab is active, and the 'Multicast Codec' dropdown menu is highlighted with a red box, showing 'G722' selected. Other settings include 'Call Waiting' (Enabled), 'Call Waiting On Code' (empty), 'Call Waiting Off Code' (empty), 'Auto Redial' (Disabled), 'DTMF Repetition' (3), 'Play Hold Tone' (Enabled), 'Play Hold Tone Delay' (30), 'Allow Mute' (Enabled), 'Dual-Headset' (Disabled), 'Auto-Answer Delay(1~4s)' (1), 'Display Method on Dialing' (User Name), and 'Auto Linekeys' (Disabled). A 'NOTE' section on the right contains the following information:

- Call Waiting:** It allows IP phones to receive a new incoming call when there is already an active call.
- Auto Redial:** It allows IP phones to automatically redial a busy number after the first attempt.
- Key As Send:** Assigns "*" or "***" as the send key.
- Hotline:** IP phone will automatically dial out the hotline number when lifting the handset, pressing the speakerphone key or the line key.
- Call Completion:** It allows users to monitor the busy party and establish a call when the busy party becomes available to receive a call.

- Click **Confirm** to accept the change.

Note If G722 codec is used for multicast paging, the LCD screen will display the icon **HD** to indicate that it is providing high definition voice.

Default codec for multicast paging is configurable via web user interface only.

Receiving RTP Stream

You can configure the phone to receive a Real Time Transport Protocol (RTP) stream from the pre-configured multicast address(es) without involving SIP signaling. You can specify up to 10 multicast addresses that the phone listens to on the network.

How the phone handles incoming multicast paging calls depends on Paging Barge and Paging Priority Active parameters configured via web user interface.

Paging Barge

The paging barge parameter defines the priority of the voice call in progress. If the priority of an incoming multicast paging call is lower than that of the active call, it will be ignored automatically. If Disabled is selected from the pull-down list of Paging Barge, the voice call in progress will take precedence over all incoming multicast paging calls. Valid values in the Paging Barge field:

- 1 to 10:** Define the priority of the active call, 1 with the highest priority, 10 with the lowest.
- Disabled:** The voice call in progress will take precedence over all incoming paging

calls.

Paging Priority Active

The paging priority active parameter decides how the phone handles incoming multicast paging calls when there is already a multicast paging call on the phone. If enabled, the phone will ignore incoming multicast paging calls with lower priorities, otherwise, the phone will answer incoming multicast paging calls automatically and place the previous multicast paging call on hold. If disabled, the phone will automatically ignore all incoming multicast paging calls.

To configure multicast listening addresses via web user interface:

1. Click on **Directory->Multicast IP**.
2. Select the desired value from the pull-down list of **Paging Barge**.
3. Select the desired value from the pull-down list of **Paging Priority Active**.
4. Enter the multicast IP address(es) and port number (e.g., 224.5.6.20:10008) which the phone listens to for incoming RTP multicast in the **Listening Address** field.
5. Enter the label in the **Label** field.

Label will appear on the LCD screen when receiving the multicast RTP stream.

The screenshot shows the 'Multicast Listening' configuration page in the Yealink T236 web interface. The 'Paging Barge' dropdown is set to '10' and 'Paging Priority Active' is set to 'Enabled'. The table below has the following data for the first row:

IP Address	Listening Address	Label	Priority
1 IP Address	224.5.6.20:10008	Product	1
2 IP Address			2
3 IP Address			3
4 IP Address			4
5 IP Address			5
6 IP Address			6
7 IP Address			7
8 IP Address			8
9 IP Address			9
10 IP Address			10

The 'NOTE' box on the right states: 'Multicast Paging: Multicast paging allows IP phones to send/receive Real-time Transport Protocol (RTP) streams to/from the pre-configured multicast address(es) without involving SIP signaling. Up to 10 listening multicast addresses can be specified on the IP phone. You can click here to get more guides.'

6. Click **Confirm** to accept the change.

Note

The priorities of listening addresses are predefined: 1 with the highest priority, 10 with the lowest.

Multicast listening addresses are configurable via web user interface only.

Using Multicast Paging

To send RTP stream via a multicast paging key when the receiver's phone is idle:

1. Press the multicast paging key when the phone is idle.

The phone sends RTP to a preconfigured multicast address (IP: Port).

Both the sender's and receiver's phones play a warning tone and the receiver automatically answers the multicast RTP session in the speakerphone mode.

The multicast paging key LED illuminates solid green.

The following figure shows a multicast RTP session on the phone:



2. To place the current multicast RTP session on hold, press the **Hold** soft key.
The sender's phone places the multicast RTP session on hold and receiver's phone releases the session.
3. To resume the held multicast RTP session, press the **Resume** soft key.
The multicast RTP session is established again.
4. To end the multicast RTP session, press the **EndCall** soft key.

Note

Multicast RTP is one way only from the sender to the multicast address(es) (receiver). For outgoing RTP multicasts, all other existing calls on the phone will be placed on hold.

To send RTP stream via a paging key list when the receiver's phone is idle:

1. Press the paging list key when the phone is idle.
2. Press or to select the desired group.

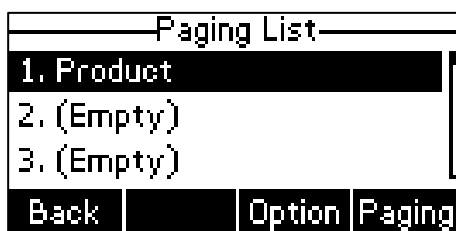

3. Press or the **Paging** soft key to send RTP.
4. To place the current multicast RTP session on hold, press the **Hold** soft key.
The sender's phone places the multicast RTP session on hold and receiver's phone releases the session.
5. To resume the held multicast RTP session, press the **Resume** soft key.
The multicast RTP session is established again.
6. To end the multicast RTP session, press the **EndCall** soft key.

Music on Hold

Music on hold (MoH) is the business practice of playing recorded music to fill the silence that would be heard by the party placed on hold. To use this feature, you should specify a SIP URI pointing to a Music on Hold Server account. When a call is placed on hold, the phone will send a SIP INVITE message to the Music on Hold Server account. The Music on Hold Server account automatically answers the SIP INVITE messages and immediately plays audio from some source located anywhere (LAN, Internet) to the held party. Contact your system administrator for the SIP URI.

To configure music on hold server via web user interface:

1. Click on **Account->Advanced**.
2. Select the desired account from the pull-down list of **Account**.
3. Enter the SIP URI (e.g., sip:moh@sip.com) in the **Music Server URI** field.

The screenshot shows the Yealink T23G web user interface. The 'Account' tab is selected, and the 'Advanced' sub-tab is active. The 'Music Server URI' field is highlighted with a red box and contains the value 'sip:moh@sip.com'. Other fields include 'Keep Alive Type', 'Keep Alive Interval(Seconds)', 'RPort', 'Subscribe Period(Seconds)', 'SIP Server Type', 'Directed Call Pickup Code', 'Group Call Pickup Code', 'Distinctive Ring Tones', 'Unregister When Reboot', 'Out Dialog BLF', 'VQ RTPC-XR Collector name', 'VQ RTPC-XR Collector address', and 'VQ RTPC-XR Collector port'. A 'NOTE' section on the right provides information about DTMF, Session Timer, Busy Lamp Field/BLF List, Shared Call Appearance (SCA)/ Bridge Line Appearance (BLA), and Network Conference.

4. Click **Confirm** to accept the change.

When you have placed a call on hold, the held party can hear the music.

Note

For this feature to function, all involved parties cannot use encrypted RTP (SRTP).
Music on hold server is configurable via web user interface only.

Automatic Call Distribution (ACD)

ACD is often used in offices for customer service, such as call center. The ACD system handles large volumes of incoming calls from callers who have no need to talk to a

specific person but who require assistance from any of multiple persons at the earliest opportunity. ACD on the SIP-T23P/G IP phone allows the ACD system to distribute large volumes of incoming calls to the registered ACD users. To use this feature, you should configure an ACD key in advance.

Note

Make sure ACD is enabled on your IP phone. For more information on enabling ACD, contact your system administrator.

To configure an ACD key via phone user interface:

1. Press **Menu->Features->DSS Keys**.
2. Select the desired DSS key.
3. Press ◀ or ▶ , or the **Switch** soft key to select **ACD** from the **Type** field.

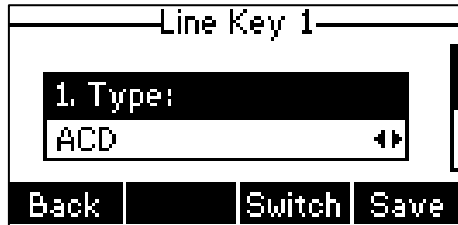

4. (Optional.) Enter the string that will appear on the LCD screen in the **Label** field.
5. Press the **Save** soft key to accept the change or the **Back** soft key to cancel.

ACD key is configurable via web user interface at the path **DSSKey->Line Key**.

To log into the ACD system:

1. Press the ACD key when the phone is idle.

The LCD screen prompts you the following information:

User ID: the identity used to log into the queue.

Password: the password used to log into the queue.



2. Press the **Login** soft key to log in.

Note

Contact your system administrator for the User ID and Password to access the ACD system.

After configuring an ACD key, you can press the ACD key to log into the ACD system.

After logging in, you are ready to receive calls from the ACD system. You can press the ACD key to show your current ACD user status. You can press the **Avail/Unavail** soft key to change your ACD user status. ACD user status synchronizes on both IP phone and ACD system.

When you set the ACD user status to be available, the ACD key LED illuminates solid green, and then the server begins distributing calls to your phone. When you set the ACD user status to be unavailable, the ACD key LED flashes green, and then the server temporarily stops distributing calls to your phone. To log out of the ACD system, press the **Logout** soft key.

Note

It is recommended you configure no more than one ACD key per phone. At any time, at most one ACD key can be in progress on your phone.

Shared Call Appearance (SCA)

You can use SCA feature to share an extension which can be registered on two or more IP phones at the same time. The shared line is indicated by a different line icon.

In the following figure, the first line is private and the second line is shared:

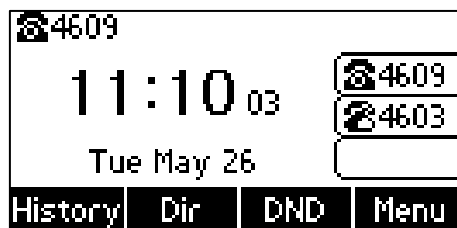

If two phones share a line, an incoming call to this extension will cause both phones to ring simultaneously. The incoming call can be answered on either phone but not both.

This feature is very useful in the boss and secretary scenario. For example, the secretary can share the boss's extension on her phone. When there is an incoming call to the extension of the boss, both the phones of the boss and the secretary will ring simultaneously. Either the boss or the secretary can answer the call. Calls on the shared line can be placed on hold, barged in or retrieved from another shared phone.

Configuring SCA Feature on the IP Phone

You can configure a primary account on the IP phone and other alternate accounts on the other IP phones. In a SCA Hybrid Key System scenario, you can automatically assign multiple DSS keys with Line type for a registered shared line on the phone (If auto linekeys feature is enabled). For example, party A, party B share the account 4603, phone A registers the primary account 4603 and assigns line key 1 and line key 2 for the account 4603, phone B registers the alternate account 4603_1 and assigns line key 1 and line key 2 for the account 4603_1, phone C registers the account 4604.

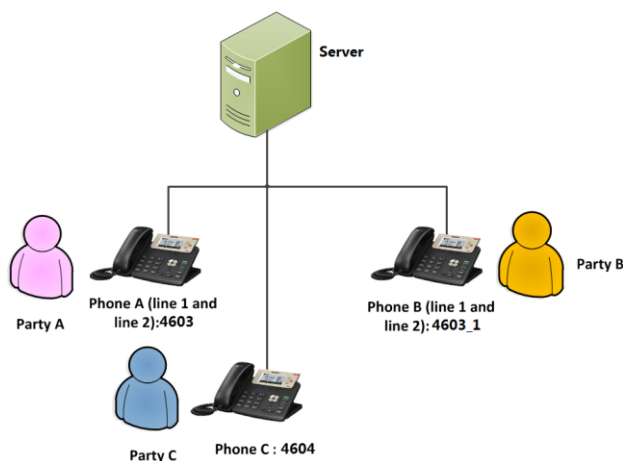

To configure the auto linekeys feature via web user interface:

1. Click on **Features-> General Information**.
2. Select **Enabled** from the pull-down list of **Auto LineKeys**.

If **Auto LineKeys** is enabled, you can automatically assign multiple DSS keys with Line type for a registered shared line on the phone.

The screenshot shows the Yealink T23G web interface. The 'Features' tab is selected, and the 'General Information' section is active. The 'Auto Linekeys' option is set to 'Enabled' and is highlighted with a red box. The 'NOTE' sidebar on the right contains the following information:

- Call Waiting:** It allows IP phones to receive a new incoming call when there is already an active call.
- Auto Redial:** It allows IP phones to automatically redial a busy number after the first attempt.
- Key As Send:** Assigns "*" or "#" as the send key.
- Hotline:** IP phone will automatically dial out the hotline number when lifting the handset, pressing the speakerphone key or the line key.
- Call Completion:** It allows users to monitor the busy party and establish a call when the busy party becomes available to receive a call.

3. Click **Confirm** to accept the change.

To configure the shared line settings and the number of line key on phone A via web user interface:

1. Register the primary account 4603.

The screenshot shows the Yealink T236 web interface for account registration. The 'Account' tab is selected, and 'Account 1' is chosen. The 'Register' section is active, showing a 'Basic' configuration. The 'SIP Server 1' section is highlighted with a red box, showing the following fields: Line Active (Enabled), Label (4603), Display Name (4603), Register Name (4603), User Name (4603), Password (masked), Server Host (pbx.yealink.com), and Port (5060). The 'SIP Server 2' section is also visible but not highlighted. The 'Outbound Proxy Server' section is highlighted with a red box, showing: Enable Outbound Proxy Server (Enabled), Outbound Proxy Server 1 (10.1.8.11), Port (5060), Outbound Proxy Server 2 (empty), Port (5060), Proxy Fallback Interval (3600), and NAT (Disabled). The 'NOTE' section on the right contains information about Account Registration, Server Redundancy, and NAT Traversal. At the bottom, there are 'Confirm' and 'Cancel' buttons.

2. Click on **Advanced**, and then select **Shared Call Appearance** from the pull-down list of **Shared Line**.
3. Enter the desired number in the **Number of line key** field.
This field appears only if **Auto Linekeys** is enabled.

The default value is 1. In this example, the value is set to 2.

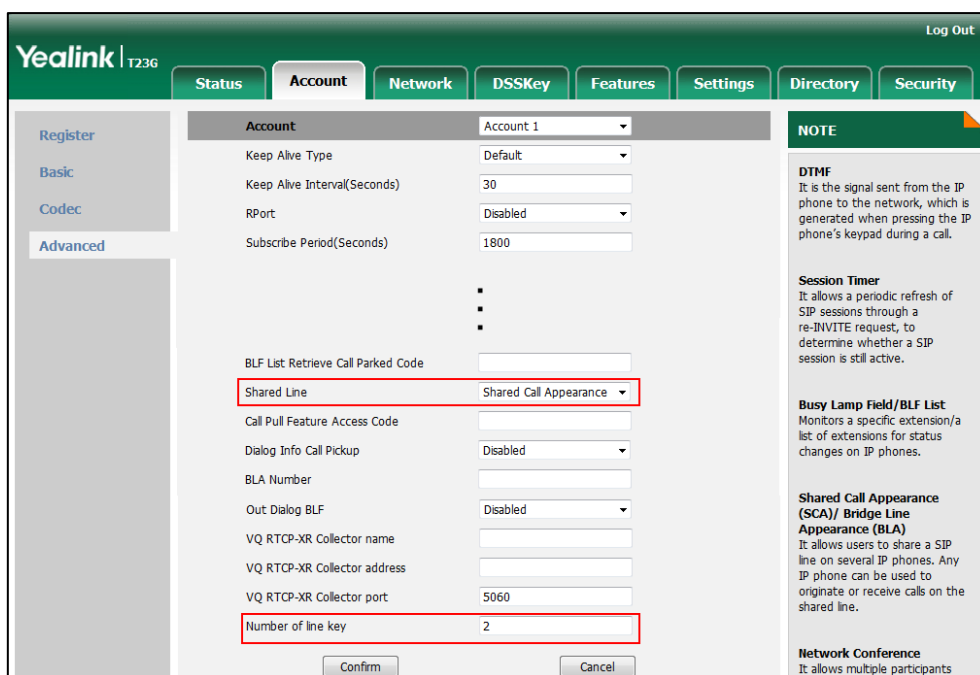

4. Click **Confirm** to accept the change.

The phone A will automatically configure the line keys from the first unused DSS key, according to the configured number in the **Number of line key** field.

To configure the shared line settings and the number of line key on phone B via web user interface:

1. Register the alternate account 4603_1.

(Enter the primary account 4603 in the **Register Name** field.)

The screenshot shows the Yealink T236 web interface for account configuration. The 'Account' tab is active, and the account is 'Account 1'. The 'Register Name' field is set to '4603'. The 'SIP Server 1' section is configured with 'Server Host' as 'pbx.yealink.com' and 'Port' as '5060'. The 'Outbound Proxy Server' section is also configured with 'Outbound Proxy Server 1' as '10.1.8.11' and 'Port' as '5060'. The 'NAT' dropdown is set to 'Disabled'. A 'NOTE' section on the right provides information about Account Registration, Server Redundancy, and NAT Traversal.

Account	
Register Status	Registered
Line Active	Enabled
Label	4603_1
Display Name	4603_1
Register Name	4603
User Name	4603_1
Password	*****
SIP Server 1	
Server Host	pbx.yealink.com Port: 5060
Transport	UDP
Server Expires	3600
Server Retry Counts	3
SIP Server 2	
Server Host	Port: 5060
Transport	UDP
Server Expires	3600
Server Retry Counts	3
Outbound Proxy Server	
Enable Outbound Proxy Server	Enabled
Outbound Proxy Server 1	10.1.8.11 Port: 5060
Outbound Proxy Server 2	Port: 5060
Proxy Fallback Interval	3600
NAT	Disabled

2. Click on **Advanced**, and then select **Shared Call Appearance** from the pull-down list of **Shared Line**.
3. Enter the desired number in the **Number of line key** field.
This field appears only if **Auto Linekeys** is enabled.

The default value is 1. In this example, the value is set to 2.

The screenshot shows the Yealink T236 web interface. The 'Account' tab is selected, and the 'Account' settings are displayed. The 'Number of line key' field is highlighted with a red box and set to 2. Other fields include 'Keep Alive Type' (Default), 'Keep Alive Interval(Seconds)' (30), 'RPort' (Disabled), 'Subscribe Period(Seconds)' (1800), 'BLF List Retrieve Call Parked Code', 'Shared Line' (Shared Call Appearance), 'Call Pull Feature Access Code', 'Dialog Info Call Pickup' (Disabled), 'BLA Number', 'Out Dialog BLF' (Disabled), 'VQ RTPC-XR Collector name', 'VQ RTPC-XR Collector address', and 'VQ RTPC-XR Collector port' (5060). A 'NOTE' section on the right provides information about DTMF, Session Timer, Busy Lamp Field/BLF List, Shared Call Appearance (SCA)/ Bridge Line Appearance (BLA), and Network Conference.

4. Click **Confirm** to accept the change.

The phone B will automatically configure the line keys from the first unused DSS key, according to the configured number in the **Number of line key** field.

Configuring private hold soft key or private hold key

Public hold allows any shared line to retrieve the held call. Private hold only allows the hold party to retrieve the held call. For example, you can retrieve the held call on either phone A or phone B when you place a call on public hold; you can retrieve the held call only on phone A when you place a call on private hold on phone A. By default, the private hold soft key isn't displayed on the LCD screen. You need to configure either the private hold soft key or a private hold key before you place the call on private hold.

To configure the private hold soft key via web user interface:



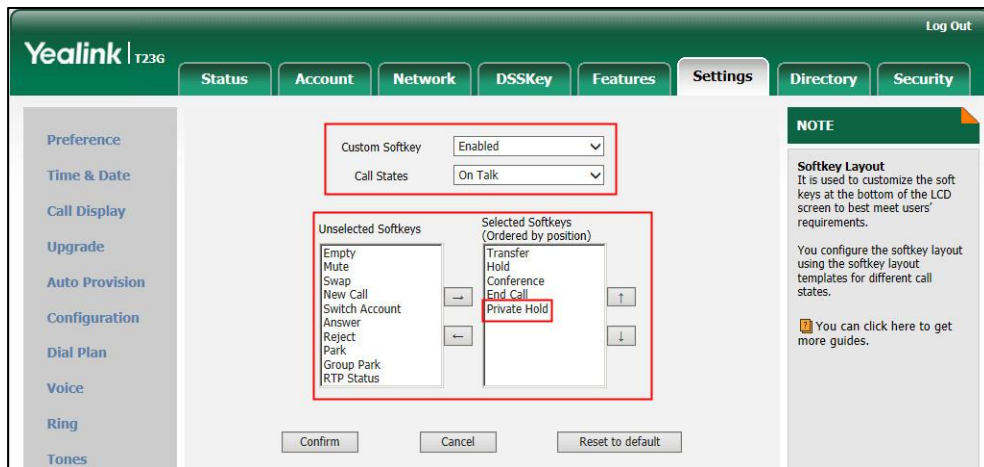

1. Click on **Settings->Softkey Layout**.
2. Select **Enabled** from the pull-down list of **Custom Softkey**.
3. Select **On Talk** from the pull-down list of **Call States**.

- Select **Private Hold** from the **Unselected Softkeys** column and then click  .
The **Private Hold** appears in the **Selected Softkeys** column.



- Click **Confirm** to accept the change.

To configure a private hold key via phone user interface:

- Press **Menu->Features->DSS Keys**.
- Select the desired DSS key.
- Press  or  , or the **Switch** soft key to select **Key Event** from the **Type** field.
- Press  or  , or the **Switch** soft key to select **Private Hold** from the **Key Type** field.

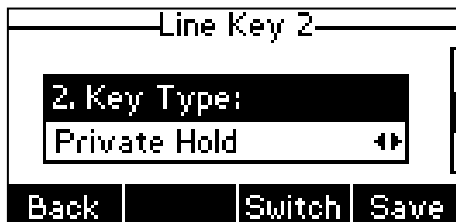

- (Optional.) Enter the string that will appear on the LCD screen in the **Label** field.
- Press the **Save** soft key to accept the change or the **Back** soft key to cancel.

Configuring call pull feature

Call pull feature allows users to retrieve an existing call from another shared phone that is in active or public hold status.

To configure the call pull feature access code via web user interface:

- Click on **Account->Advanced**.
- Select the desired account from the pull-down list of **Account**.

- Enter the call pull feature access code (e.g., *11) in the **Call Pull Feature Access Code** field.

The screenshot shows the Yealink T236 web interface. The 'Account' tab is selected, and the 'Account 1' settings are displayed. The 'Call Pull Feature Access Code' field is highlighted with a red box and contains the value '*11'. Other settings include Keep Alive Type (Default), Keep Alive Interval (30), RPort (Disabled), and Subscribe Period (1800). A 'NOTE' section on the right provides information about DTMF, Session Timer, Busy Lamp Field/BLF List, Shared Call Appearance (SCA)/ Bridge Line Appearance (BLA), and Network Conference.

- Click **Confirm** to accept the change.
The phone will dial out “*11” automatically when you press the **CallPull** soft key.

Using SCA Feature on the IP Phone

This section provides you with detailed information on using the SIP-T23P/G IP phone in a SCA Hybrid Key System scenario. In a SCA Hybrid Key System scenario, the status of the line key LED which associates with a shared line will change. For more information on line key LED indicators, refer to [LED Instructions](#) on page 14.

You can do the following using the IP phone in a SCA Hybrid Key System scenario:





- Placing calls
- Answering calls
- Placing a call on hold
- Retrieving a held call
- Barging in an active call
- Call Pull

Placing Calls

You can have one call or multiple calls on the shared line.





To place a call on the shared line:

Do one of following:

- Enter the desired number using the keypad when the phone is idle.
Press  ,  , or the **Send** soft key.
The phone will dial the entered number using the first line key.
- Press the line key when the phone is idle to enter the pre-dialing screen.
Enter the desired number using the keypad and then press  ,  , or the **Send** soft key.
The phone will dial the entered number using the selected line key.

To place multiple calls on the shared line:

You can have more than one call on the shared line. To place a new call when there is an active call on the line key 1 of phone A, do one of the following on phone A:

- Press the **Hold** soft key. The original call is placed on hold.
Press the **NewCall** soft key to enter the pre-dialing screen.
Enter the desired number using the keypad.
Press  ,  , or the **Send** soft key.
Phone A will dial the entered number using the line key 2 automatically.
- Press the line key. The original call is placed on hold.
Enter the desired number using the keypad.
Press  ,  , or the **Send** soft key.
Phone A will dial the entered number using the selected line key.



Answering Calls

You can have one call or multiple calls on the shared line. Incoming calls will be distributed evenly among the available line keys.



To answer a call on the shared line:

When an incoming call arrives on the shared line, the phone A and phone B will ring simultaneously, and the LED indicators of the line key 1 on both phone A and phone B will flash green. You can answer the incoming call on either phone A or phone B but not both.

Do one of the following on phone A or phone B:

- Press the line key 1,  ,  or the **Answer** soft key on phone A.
The LED indicators of the line key 1 on phone A will illuminate solid green and phone

B will illuminate solid red.

- Press the line key 1, ,  or the **Answer** soft key on phone B.

The LED indicators of the line key 1 on phone A will illuminate solid red and phone B will illuminate solid green.

To answer multiple calls on the shared line:

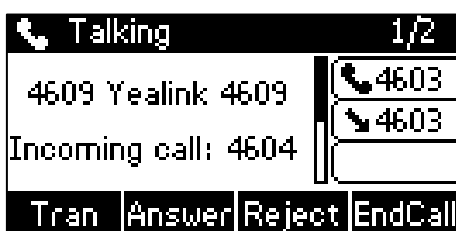

An incoming call arrives on the shared line when there is an active call on phone A's line key 1. The LED indicators of the line key 2 on both phone A and phone B will fast flash green. You can answer the incoming call on either phone A or phone B. The LCD screen of phone A displays the information of the incoming call (e.g., "Incoming call: 4604 Yealink").



Note

Make sure call waiting feature is enabled on phone A. For more information, refer to [Call Waiting](#) on page 111.

Do one of the following on phone A:

- Press the line key 2. Phone B stops ringing.
- Press the **Answer** soft key. Phone B stops ringing.
- Press  to access the new call.
Press  or the **Answer** soft key. Phone B stops ringing.

The incoming call is answered and the original call is placed on hold. The LED indicators of the line key 1 on phone A will slow flash green and phone B will slow flash red indicating that there is the held call on the line key 1. The LED indicators of the line key 2 on phone A will illuminate solid green and phone B will illuminate solid red indicating that there is an active call on the line key 2.

You can also answer the call on phone B. Do one of the following on phone B:

- Press the line key 2. Phone A stops ringing.
- Press  or the **Answer** soft key. Phone A stops ringing.

The LED indicators of the line key 2 on phone A will illuminate solid red and phone B will illuminate solid green indicating that there is an active call on the line key 2. Meanwhile, The LED indicators of the line key 1 phone A will illuminate solid green and phone B will illuminate solid red indicating that there is an active call on the line key 1.

Note

If the number of incoming calls is greater than the configured line keys, the line keys will be used by sequence circulation.

Placing a Call on Hold

To place a call on public hold:

1. Press the **Hold** soft key on phone A when party A and party C are talking.

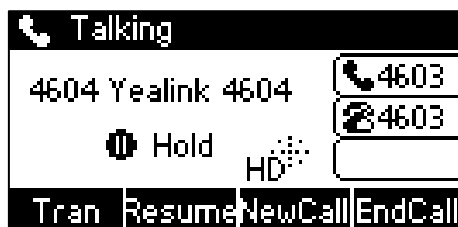

The line key LEDs on phone A slow flash green and phone B slow flash red when the shared line call is placed on hold.

To place a call on private hold:

1. Press the **PriHold** soft key or private hold key on phone A when there is an active call on the shared line (You may need to press the **More** soft key to see the **PriHold** soft key).

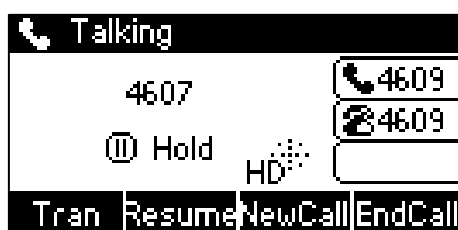

The line key LED slow flashes green on phone A when the shared line call is placed on private hold.

The line key LED illuminates solid red on phone B when the shared line call is placed on private hold.

Retrieving a Held Call

To retrieve a call placed on public hold:

You can retrieve the public held call on either phone A or phone B.

To retrieve the call on phone A:

1. Press the line key with the slow flashing green LED indicator or the **Resume** soft key.
The conversation between phone A and phone C is retrieved.

To retrieve the call on phone B:

Do one of the following:

- Press the line key with the slow flashing red LED indicator.
- Long press the desired line key. The **Cancel**, **CallPull**, **NewCall** and **Retrieve** soft keys appear on the LCD screen.

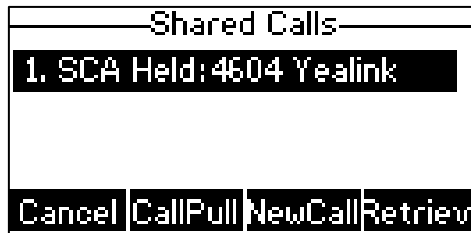

Press the **Retrieve** soft key to retrieve the call.

The conversation is established between phone B and phone C, phone A disconnects the call. And the line key LED on phone A illuminates solid red and phone B illuminates solid green.

To retrieve a call placed on private hold:

The private held call can be only retrieved by the hold party (party A).

Do one of the following:

- Press the line key with the slow flashing green LED indicator.
- Press the **Resume** soft key on phone A.

Barging In an Active Call

To interrupt the active call on the shared line:

If phone A has only one active call, do the following:

1. Long press the desired line key on phone B.
The **Cancel**, **CallPull**, **NewCall** and **Barge In** soft keys appear on the LCD screen of phone B.

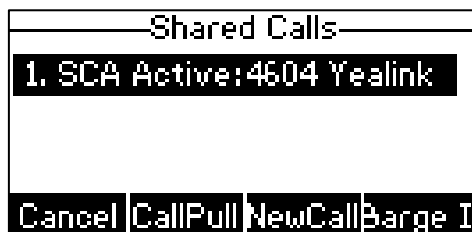



2. Press the **Barge In** soft key to interrupt the active call of phone A.
Party B will set up a conference call with the other parties in the active call.
3. Press the **Hold** or the **EndCall** soft key.
 - If any party in the conference call presses the **Hold** soft key, two-way voice can be heard between the remaining parties.
 - If party A or party B presses the **EndCall** soft key, the remaining parties are still connected. If the other party (not the shared line party) presses the **EndCall** soft key, the conference call is ended.

You can also press the line key with the solid red LED indicator on phone B to set up a conference call with the other parties in the active call.

If phone A has more than one call, do the following:

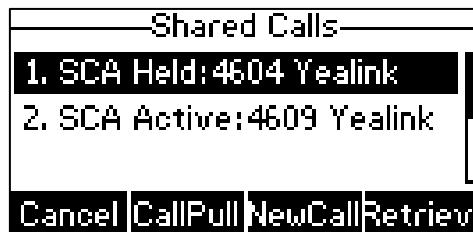
1. Long press the desired line key on phone B.
The list of calls appears on the LCD screen of phone B.



2. Press  or  to select the active call.
The **Cancel**, **CallPull**, **NewCall** and **Barge In** soft keys appear when the active call is highlighted.

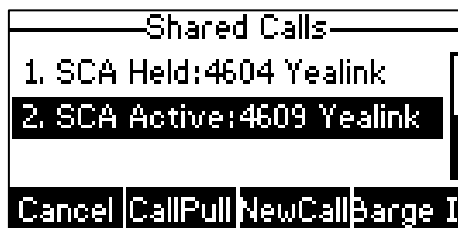

3. Press the **Barge In** soft key to interrupt the active call of phone A.
Party B may hear a warning tone and then set up a conference call with the other parties of the active call.
4. Press the **Hold** or the **EndCall** soft key.
 - If any party in the conference call presses the **Hold** soft key, two-way voice can be heard between the remaining parties.
 - If party A or party B presses the **EndCall** soft key, the remaining parties are still connected. If the other party (not the shared line party) presses the **EndCall** soft key, the conference call is ended.

Call Pull

Call pull feature allows users to retrieve an existing call from another shared phone that is in active or hold status. For example, when there is a call between phone A and phone C, you can use call pull feature on phone B to retrieve this call from phone A. Then the call is established between phone B and phone C.

To retrieve a call from another shared phone:

If there is an active call between phone A and phone C, do the following:

1. Long press the desired line key on phone B.

The **Cancel**, **CallPull**, **NewCall** and **Barge In** soft keys appear on the LCD screen of phone B.



2. Press the **CallPull** soft key.

The active call has been retrieved from the phone A successfully.

If there is a held call between phone A and phone C, do the following:

1. Long press the desired line key on phone B.

The **Cancel**, **CallPull**, **NewCall** and **Retrieve** soft keys appear on the LCD screen of phone B.



2. Press the **CallPull** soft key.

The held call has been retrieved from the phone A successfully.

Bridged Line Appearance (BLA)

BLA allows users to share a SIP line on two or more IP phones. Users can monitor the specific extension (BLA number) for status changes on each IP phone. To use this feature, a BLA group should be pre-configured on the server and one of them is specified as a BLA number. BLA depends on support from a SIP server.

In the following figure, the first line is private and the second line is shared:

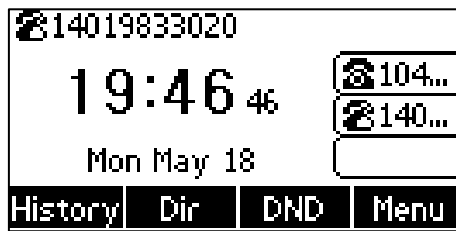

Any IP phone can be used to originate or receive calls on the bridged line. An incoming call to the BLA number can be presented to multiple phones in the group simultaneously. The incoming call can be answered on any IP phone of the group but not all.

Configuring BLA Feature on the IP Phone

You can share a BLA number on two or more phones. For example, phone A registers the account 14019833020 and assigns BLA number, phone B registers the account 10462190020 and assigns BLA number, phone C registers the account 14755608020. Phone A and phone B share the BLA number 14084588327.

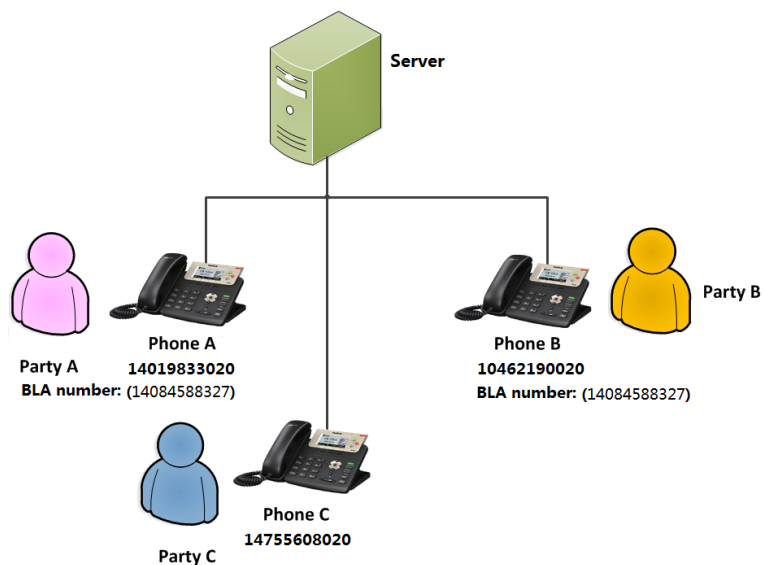

To register an account and configure BLA feature on phone A via web user interface:

1. Register the account 14019833020.

Yealink T236 | Log Out

Status | **Account** | Network | DSSKey | Features | Settings | Directory | Security

Register Status: Account 1 | Registered

Line Active: Enabled

Label: 14019833020

Display Name: 14019833020

Register Name: 14019833020

User Name: 14084588327

Password: *****

SIP Server 1

Server Host: sip.ringcentral.com | Port: 5060

Transport: UDP

Server Expires: 3600

Server Retry Counts: 3

SIP Server 2

Server Host: | Port: 5060

Transport: UDP

Server Expires: 3600

Server Retry Counts: 3

Enable Outbound Proxy Server: Enabled

Outbound Proxy Server 1: sip114.ringcentral.com | Port: 5099

Outbound Proxy Server 2: | Port: 5060

Proxy Fallback Interval: 3600

NAT: Disabled

Confirm | Cancel

NOTE

Account Registration
Registers account(s) for the IP phone.

Server Redundancy
It is often required in VoIP deployments to ensure continuity of phone service, for events where the server needs to be taken offline for maintenance, the server fails, or the connection between the IP phone and the server fails.

NAT Traversal
A general term for techniques that establish and maintain IP connections traversing NAT gateways. STUN is one of the NAT traversal techniques.

You can configure NAT traversal for this account.

[You can click here to get more guides.](#)

2. Click on **Advanced**, and then select **Draft BLA** from the pull-down list of **Shared Line**.
3. Enter the desired number in the **BLA Number** field.

Yealink T236 | Log Out

Status | **Account** | Network | DSSKey | Features | Settings | Directory | Security

Keep Alive Type: Default

Keep Alive Interval(Seconds): 30

RPort: Disabled

Subscribe Period(Seconds): 1800

BLF List Retrieve Call Parked Code: |

Shared Line: Draft BLA

Dialog Info Call Pickup: Disabled

BLA Number: 14084588327

BLA Subscription Period: 300

SIP Send MAC: Disabled

SIP Send Line: Disabled

SIP Registration Retry Timer(0~1800s): 30

VQ RTPC-XR Collector address: |

VQ RTPC-XR Collector port: 5060

Confirm | Cancel

NOTE

DTMF
It is the signal sent from the IP phone to the network, which is generated when pressing the IP phone's keypad during a call.

Session Timer
It allows a periodic refresh of SIP sessions through a re-INVITE request, to determine whether a SIP session is still active.

Busy Lamp Field/BLF List
Monitors a specific extension/a list of extensions for status changes on IP phones.

Shared Call Appearance (SCA)/ Bridge Line Appearance (BLA)
It allows users to share a SIP line on several IP phones. Any IP phone can be used to originate or receive calls on the shared line.

Network Conference
It allows multiple participants

4. Click **Confirm** to accept the change.

To register an account and configure BLA feature on phone B via web user interface:

1. Register the account 10462190020.

The screenshot shows the Yealink T736 web interface for account configuration. The 'Account' tab is selected, and the 'Account 1' dropdown is visible. The 'Register Status' is 'Registered'. The 'Line Active' dropdown is set to 'Enabled'. The 'Outbound Proxy Server' dropdown is also set to 'Enabled'. The 'Outbound Proxy Server 1' field is set to 'sp214.ringcentral.com' with port '5099'. The 'Register Status' is 'Registered'. The 'Label' is '10462190020', 'Display Name' is '10462190020', 'Register Name' is '10462190020', 'User Name' is '14084588327', and 'Password' is masked with '*****'. The 'SIP Server 1' section shows 'Server Host' as 'sp.ringcentral.com' with port '5060' and 'Transport' as 'UDP'. The 'SIP Server 2' section shows 'Server Host' as an empty field with port '5060' and 'Transport' as 'UDP'. The 'Proxy Fallback Interval' is '3600' and 'NAT' is 'Disabled'. The 'Confirm' and 'Cancel' buttons are at the bottom.

Field	Value
Register Status	Registered
Line Active	Enabled
Label	10462190020
Display Name	10462190020
Register Name	10462190020
User Name	14084588327
Password	*****
SIP Server 1	
Server Host	sp.ringcentral.com Port: 5060
Transport	UDP
Server Expires	3600
Server Retry Counts	3
SIP Server 2	
Server Host	Port: 5060
Transport	UDP
Server Expires	3600
Server Retry Counts	3
Enable Outbound Proxy Server	Enabled
Outbound Proxy Server 1	sp214.ringcentral.com Port: 5099
Outbound Proxy Server 2	Port: 5060
Proxy Fallback Interval	3600
NAT	Disabled

2. Click on **Advanced**, and then select **Draft BLA** from the pull-down list of **Shared Line**.

- Enter the desired number in the **BLA Number** field.

The screenshot shows the Yealink T23G web interface with the 'Account' tab selected. The 'BLA Number' field is highlighted with a red box and contains the value '14084588327'. Other fields include 'Shared Line' (Draft BLA), 'Dialog Info Call Pickup' (Disabled), 'BLA Subscription Period' (300), 'SIP Send MAC' (Disabled), 'SIP Send Line' (Disabled), 'SIP Registration Retry Timer(0~1800s)' (30), 'VQ RTPC-XR Collector address', and 'VQ RTPC-XR Collector port' (5060). A 'NOTE' section on the right provides information about DTMF, Session Timer, Busy Lamp Field/BLF List, Shared Call Appearance (SCA)/ Bridge Line Appearance (BLA), and Network Conference.

- Click **Confirm** to accept the change.

Using BLA Feature on the IP Phone

This section provides you with detailed information on using the SIP-T23P/G IP phone in a BLA scenario. In a BLA scenario, the status of the line key LED which associates with a bridged line will change. For more information on line key LED indicators, refer to [LED Instructions](#) on page 14.

You can do the following using the IP phone in a BLA scenario:

- Placing calls
- Answering calls
- Place a call on hold
- Retrieving a held call



Placing Calls

You can have one call or multiple calls on the bridged line.



To place a call on the bridged line:

Do one of following:

- Enter the desired number using the keypad when the phone is idle.





Press , , or the **Send** soft key.

The phone will dial the entered number.

- Press the line key when the phone is idle to enter the pre-dialing screen.
Enter the desired number using the keypad and then press  ,  , or the **Send** soft key.
The phone will dial the entered number.

To place multiple calls on the bridged line:





You can have more than one call on the bridged line. To place a new call when there is an active call on phone A, do one of the following on the phone A:

- Press the **Hold** soft key. The original call is placed on hold.
Press the **NewCall** soft key to enter the pre-dialing screen.
Enter the desired number using the keypad.
Press  ,  , or the **Send** soft key.
Phone A will dial the entered number.
- Press the line key. The original call is placed on hold.
Enter the desired number using the keypad.
Press  ,  , or the **Send** soft key.
Phone A will dial the entered number.

Answering Calls

When the phone C dials the BLA number "14084588327", an incoming call will arrive on the bridged line. The phone A and phone B ring simultaneously and the LED indicators of the line key on both phone A and phone B will flash green. You can answer the incoming call on either phone A or phone B but not both.

Do one of the following on phone A or phone B:

- Press  ,  or the **Answer** soft key on phone A.
Phone B stops ringing. The LED indicator of the line key on the phone A will illuminate solid green. At the meanwhile, the LED indicator of the line key on the phone B will illuminate solid red indicating that there is an active call on the phone A.
- Press  ,  or the **Answer** soft key on phone B.
Phone A stops ringing. The LED indicator of the line key on the phone B will illuminate solid green. At the meanwhile, the LED indicator of the line key on the phone A will illuminate solid red indicating that there is an active call on the phone B.

Placing a Call on Hold

To place a call on hold:

1. Press the **Hold** soft key on phone A when party A and party C are talking.

The line key LEDs on phone A slow flash green and phone B slow flash red when the bridged line call is placed on hold.

Retrieving a Held Call

If there is a held call between phone A and phone C, you can retrieve a held call on either phone A or phone B.

To retrieve the held call on phone A:

1. Press the line key with the slow flashing green LED indicator or the **Resume** soft key on phone A.

The conversation between phone A and phone C is retrieved.

To retrieve the held call on phone B:

1. Press the line key with the slow flashing red LED indicator on phone B.

The conversation is established between phone B and phone C, phone A disconnects the call.

Messages

Short Message Service (SMS)

You can send and receive text messages using the SIP-T23P/G IP phone. New text messages can be indicated both acoustically and visually. When receiving a new text message, the phone will play a warning tone. The power indicator LED will slow flash red, and the LCD screen will prompt “n New Text Message(s)” (“n” indicates the number of unread text messages. e.g., 1 New Text Message(s)) and a flashing icon .

Note

When the phone receives a text message, the text message prompt window will pop up by default, if you want to disable the feature, contact your system administrator for more information.



You can store text messages in your phone's Inbox, Sentbox, Outbox or Draftbox. Each of the boxes can store up to 100 text messages. If the number of the text messages in one box is more than 100, the phone will directly delete the oldest text message in the box.

Note

SMS is not available on all servers. Contact your system administrator for more information.

To read a text message:

2. Press **Menu-> Message->Text Message->Inbox**.



3. Select the desired message and then press the **View** soft key.

Note

If the phone prompts receiving new text messages, you can also press the **View** soft key to read the new messages directly.

To send a text message:

1. Press **Menu->Message->Text Message->New Message**.
2. Compose the new text message. You can press the **abc** soft key to change the input mode.



3. Press the **Send** soft key after completing the content.
4. (Optional.) Press **◀** or **▶**, or the **Switch** soft key to select the desired account from the **From** field.
5. Enter the number you want to send the message to in the **To** field.
6. Press the **Send** soft key to send the message or the **Back** soft key to cancel.

Sending a text message is configurable via web user interface at the path **Features->SMS**.

To reply a text message:

1. Press **Menu->Message->Text Message->Inbox**.
2. Select the desired message and then press the **Reply** soft key.
3. Compose the new text message. You can press the **abc** soft key to change the input mode.



4. Press the **Send** soft key after completing the content.
5. Check the **From** and **To** fields, and then press the **Send** soft key.

To delete a text message:

1. Press **Menu->Message->Text Message->Inbox (Sentbox, Outbox or Draftbox)**.
2. Select the desired message and then press the **Delete** soft key.



3. Select **Delete** to delete the desired message, and then press the **OK** soft key. The LCD screen prompts "Delete message?".



4. Press the **OK** soft key to delete this message or the **Cancel** soft key to cancel. You can also delete all text messages by pressing the **Delete** soft key and then select **Delete All**. For more information, refer to the above steps.

Note You can also delete a specific message after retrieving by pressing the **Delete** soft key.

Voice Mail

You can leave voice mails for someone else using the SIP-T23P/G IP phone. You can also listen to voice mails that are stored in a voice mailbox. When receiving a new voice mail, the phone will play a warning tone. The power indicator LED will slow flash red, and the LCD screen will prompt “n New Voice Mail(s)” (“n” indicates the number of unread voice messages, e.g., 4 New Voice Mail(s)) and a flashing icon .

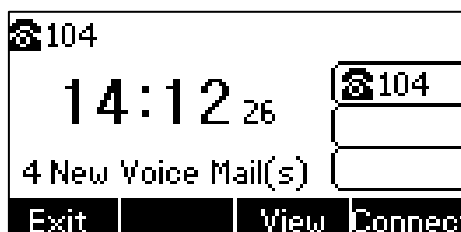

If the voice mail pop-up message box disappears, it won't pop up again unless the user receives a new voice mail or the user re-registers the account that has unread voice mail(s).

Note

Voice Mail is not available on all servers.

You can configure the phone not to display the pop-up prompt, contact your system administrator for more information.

To leave a voice mail:

You can leave a voice mail for someone else when he/she is busy or inconvenient to answer the call. Follow the voice prompt from the system server to leave a voice mail, and then hang up.

To configure voice mail access codes via phone user interface:

1. Press **Menu->Message->Voice Mail->Set Voice Mail**.
2. Press the navigation keys to highlight the account which you want to set.
3. Press the **123** soft key to select the proper input mode and then enter the voice mail access code (e.g., *97).



4. Press the **Save** soft key to accept the change or the **Back** soft key to cancel.

Note

Voice mail access codes must be predefined on the system server. Contact your system administrator for the more information.

To listen to voice mails:

1. When the LCD screen prompts that the phone receives a new voice mail and the power indicator LED slow flashes red, you can press  or the **Connect** soft key to dial out the voice mail access code.
2. Follow the voice prompt to listen to your voice mails.

Note

Before listening to voice mails, make sure the voice mail access code has been configured.

When all new voice mails are retrieved, the power indicator LED will go out.

To view the voice mail via phone user interface:

1. Press **Menu->Message->Voice Mail->View Voice Mail**.

The LCD screen displays the amount of new and old voice mails.

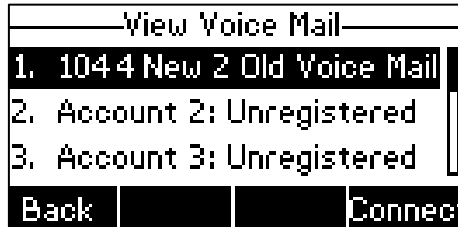

2. Select an account and then press the **Connect** soft key to listen to voice mails.

Message Waiting Indicator (MWI)

The SIP-T23P/G IP phone supports MWI when receiving a new voice message. If someone leaves you a voice mail, you will receive a message waiting indicator. MWI will be indicated in three ways: a warning tone, an indicator message (including a voice mail icon) on the LCD screen, and the power indicator LED slow flashes red. This will be cleared when you retrieve all voice mails or delete them.

The MWI service is unsolicited for some servers, so the SIP-T23P/G IP phone only handles the MWI messages sent from the server. But for other servers, the MWI service is solicited, so the SIP-T23P/G IP phone must enable subscription for MWI.

Note

MWI service is not available on all servers. Contact your system administrator for more information.

The MWI subscription parameters you need to know:

Options	Description
Subscribe for MWI	Enable or disable a subscription for MWI service.
MWI Subscription Period	Period of MWI subscription. The IP phone sends a refresh SUBSCRIBE request before initial SUBSCRIBE expiration.
Subscribe MWI To Voice Mail	Enable or disable a subscription to the voice mail number for MWI service. To use this feature, you should also configure the voice mail number.

Note The phone will send SUBSCRIBE messages for the MWI service to the account or the voice number MWI service depending on the server. Contact your system administrator for more information.

To configure subscribe for MWI via web user interface:

1. Click on **Account->Advanced**.
2. Select the desired account from the pull-down list of **Account**.
3. Select **Enabled** from the pull-down list of **Subscribe for MWI** field.
4. Enter the period time in the **MWI Subscription Period(Seconds)** field.

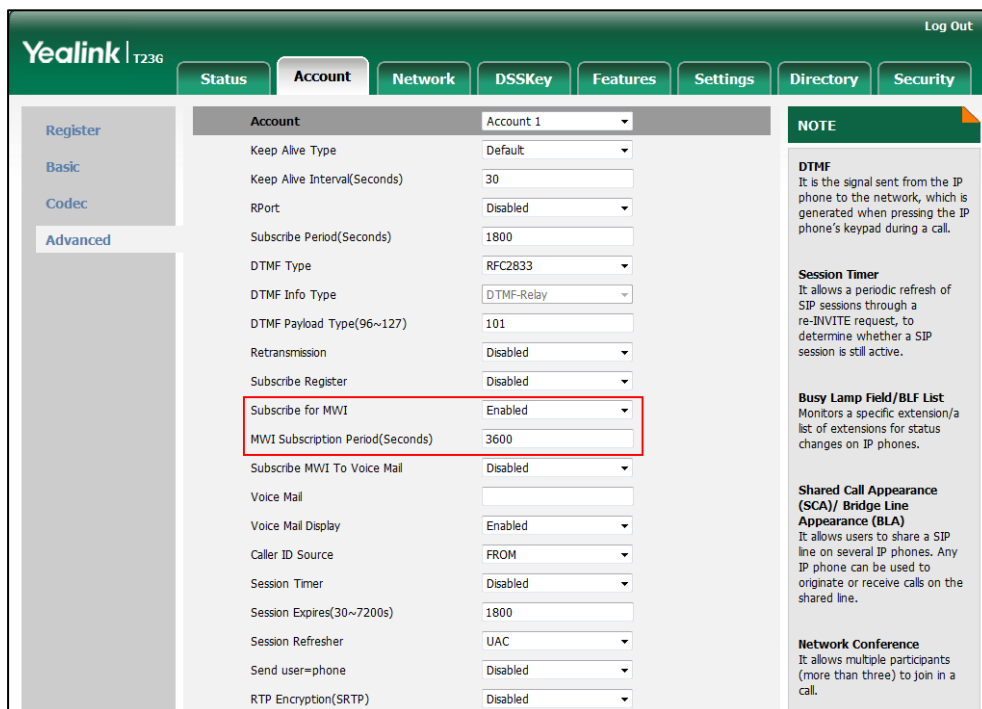

5. Click **Confirm** to accept the change.

The IP phone will subscribe to the account number for MWI service by default.

To enable subscribe MWI to voice mail via web user interface:

1. Click on **Account->Advanced**.
2. Select the desired account from the pull-down list of **Account**.
3. Select **Enabled** from the pull-down list of **Subscribe for MWI**.
4. Select **Enabled** from the pull-down list of **Subscribe MWI To Voice Mail**.
5. Enter the desired voice mail number in the **Voice Mail** field.

The screenshot shows the Yealink T23G web user interface. The 'Account' tab is active, and the 'Advanced' sub-tab is selected. The 'Account' dropdown is set to 'Account 1'. The 'Subscribe for MWI' and 'Subscribe MWI To Voice Mail' options are both set to 'Enabled'. The 'Voice Mail' field contains the number '*88'. The 'NOTE' section on the right contains the following information:

DTMF
It is the signal sent from the IP phone to the network, which is generated when pressing the IP phone's keypad during a call.

Session Timer
It allows a periodic refresh of SIP sessions through a re-INVITE request, to determine whether a SIP session is still active.

Busy Lamp Field/BLF List
Monitors a specific extension/a list of extensions for status changes on IP phones.

Shared Call Appearance (SCA)/ Bridge Line Appearance (BLA)
It allows users to share a SIP line on several IP phones. Any IP phone can be used to originate or receive calls on the shared line.

Network Conference
It allows multiple participants (more than three) to join in a call.

6. Click **Confirm** to accept the change.

The IP phone will subscribe to the voice mail number for MWI service using **Subscribe MWI To Voice Mail**.

Note

MWI subscription is configurable via web user interface only.

Troubleshooting

This chapter provides general troubleshooting information to help you solve the problems you might encounter when using your SIP-T23P/G IP phone.

If you require additional information or assistance with your new phone, contact your system administrator.

General Issues

How can I find the basic information of the IP phone?

Press the OK key when the IP phone is idle to check the basic information of the IP phone, such as IP address and firmware version. For more basic information, refer to [Phone Status](#) on page 26.

How to obtain the MAC address of a phone when the phone is not powered on?

Three ways to obtain the MAC address of a phone:

- You can ask your supplier for the shipping information sheet which includes MAC addresses according to the corresponding PO (Purchase Order).
- You can find the MAC address on the label of carton box.
- You can also find the MAC address from the phone's bar code on the back of the phone.

What is the difference between user name, register name and display name?

Both user name and register name are defined by the server. A user name is used to identify the account while a register name matched with a password is used for authentication if required by the server. Display name is the caller ID that will be displayed on the called party's LCD screen. Server configuration may override the local configuration.

Display Issues

Why is the LCD screen blank?

- Ensure that the phone is properly plugged into a functional AC outlet.
- Ensure that the phone is plugged into a socket controlled by a switch that is on.
- If the phone is plugged into a power strip, try to plug it directly into a wall outlet instead.

- If your SIP-T23P/G IP phone is powered from PoE, ensure you use a PoE-compliant switch or hub.

Why does the phone display "Network unavailable"?

- Ensure that the Ethernet cable is plugged into the Internet port on the phone and the Ethernet cable is not loose.
- Ensure that the switch or hub in your network is operational.
- Contact your system administrator for more information.

Why doesn't the phone display time and date correctly?

Check if you have configured the phone to obtain the time and date from the SNTP server automatically. If the phone fails to connect to the SNTP server, contact your system administrator for more information. You can also configure the time and date manually. For more information, refer to [Time & Date](#) on page 37.

Password Issues

Why can't I access web user interface using the default administrator user name and password (admin/admin)?

- It is case-sensitive, ensure the case is correct.
- Ensure the password has not been changed.
- If the password has been changed, but the computer remembers the old password, try to clear the browser cache and try again or select another browser to login.

How to change the user password?

To change the user password via web user interface:

1. Click on **Security**->**Password**.
2. Select **user** from the pull-down list of **User Type**.
3. Enter the new user password in the **New Password** field and **Confirm Password** field.

The screenshot shows the Yealink T23G web user interface. At the top, there is a navigation bar with tabs for Status, Account, Network, DSSKey, Features, Settings, Directory, and Security. The Security tab is active, and the Password sub-tab is selected. The main content area contains a form for changing the password. The form has a 'User Type' dropdown menu set to 'user', and three password input fields: 'Old Password', 'New Password', and 'Confirm Password'. A red rectangular box highlights the 'User Type' dropdown and the three password input fields. Below the input fields are 'Confirm' and 'Cancel' buttons. On the right side of the form, there is a 'NOTE' box with the following text: 'User Password/ Administrator Password: When logging into the web user interface, you need to enter the user name and password. You can change the user/ administrator password for security reasons. You can click here to get more guides.'

4. Click **Confirm** to accept the change.

You can also contact your system administrator for help.

Note

If you are logging into the web user interface of the phone with user credentials, you need to enter the current user password in the **Old Password** field.

User password is configurable via web user interface only.

Call Issues

Why can't I receive calls?

- Check the SIP registration with your system administrator.
- Check that the DND (Do Not Disturb) mode is deactivated on your phone. Refer to [Do Not Disturb \(DND\)](#) on page 98.
- Check that call forward is disabled on the phone. Refer to [Call Forward](#) on page 102.
- Check whether the caller number is stored in the blacklist directory. Refer to [Blacklist](#) on page 57.

Headset & Handset Issues

Why does my handset not work?

Check that the handset cord is fully connected to both the handset jack on the phone and handset. Refer to [Phone Installation](#) on page 23.

Why does my headset not work?

- Check that the headset cord is properly connected to the headset jack on the phone. Refer to [Phone Installation](#) on page 23.
- Check that the headset mode is activated. Refer to [Headset Use](#) on page 64.
- Check that the headset volume is adjusted to an appropriate level. Refer to [Volume](#) on page 43.

Audio Issues

Why can't I get a dial tone?

- Check for any loose connections and that the phone has been installed properly. For the installation instructions, refer to [Phone Installation](#) on page 23.

- Switch between the Handset, Headset (if present) or Hands-Free Speakerphone to check whether the dial tone is present for one of the audio modes.

If the dial tone exists on another audio mode, connect a different handset or headset to isolate the problem.

Why doesn't the phone ring?

Check the ringer volume on the phone. To adjust the ringer volume setting, press the Volume key when the phone is on-hook and idle. For more information, refer to [Volume](#) on page 43.

Why does the phone play a tone when there is a call on hold? How to disable it?

When there is a call on hold, the phone will play a hold tone every 30 seconds. Call hold tone is enabled by default. Call hold tone and the interval of playing a hold tone are configurable via web user interface only.

To configure call hold tone and call hold tone delay via web user interface:

1. Click on **Features->General Information**.
2. Select the desired value from the pull-down list of **Play Hold Tone**.
3. Enter the desired time in the **Play Hold Tone Delay** field.

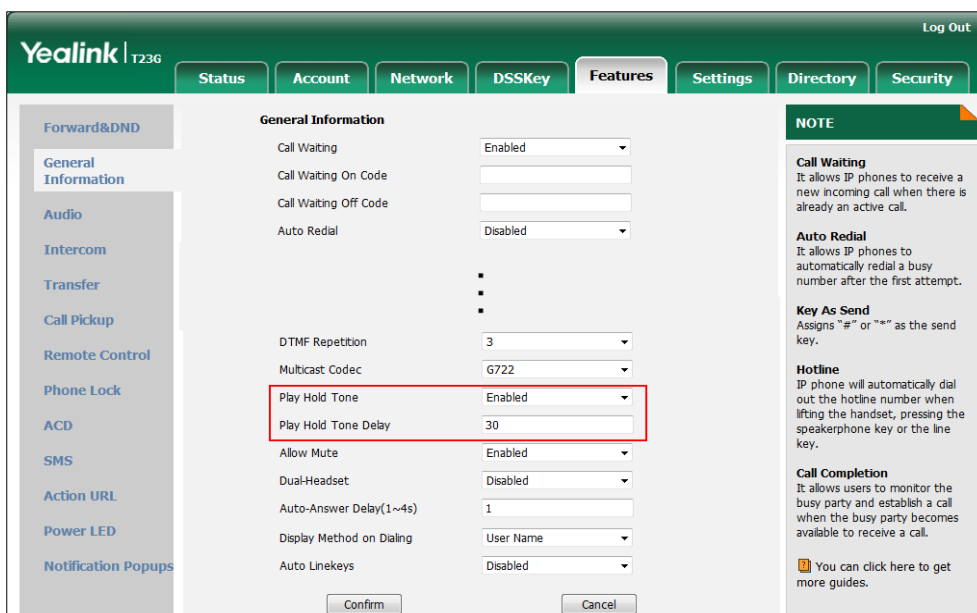

4. Click **Confirm** to accept the change.

How to make a call using SRTP?

You can enable SRTP to encrypt the audio stream(s) of phone calls. The parties participating in the call should enable SRTP on a per-line basis.

To enable SRTP on a per-line basis via web user interface:

1. Click on **Account->Advanced**.
2. Select the desired account from the pull-down list of **Account**.
3. Select the desired value (**Optional** or **Compulsory**) from the pull-down list of **RTP Encryption(SRTP)**.

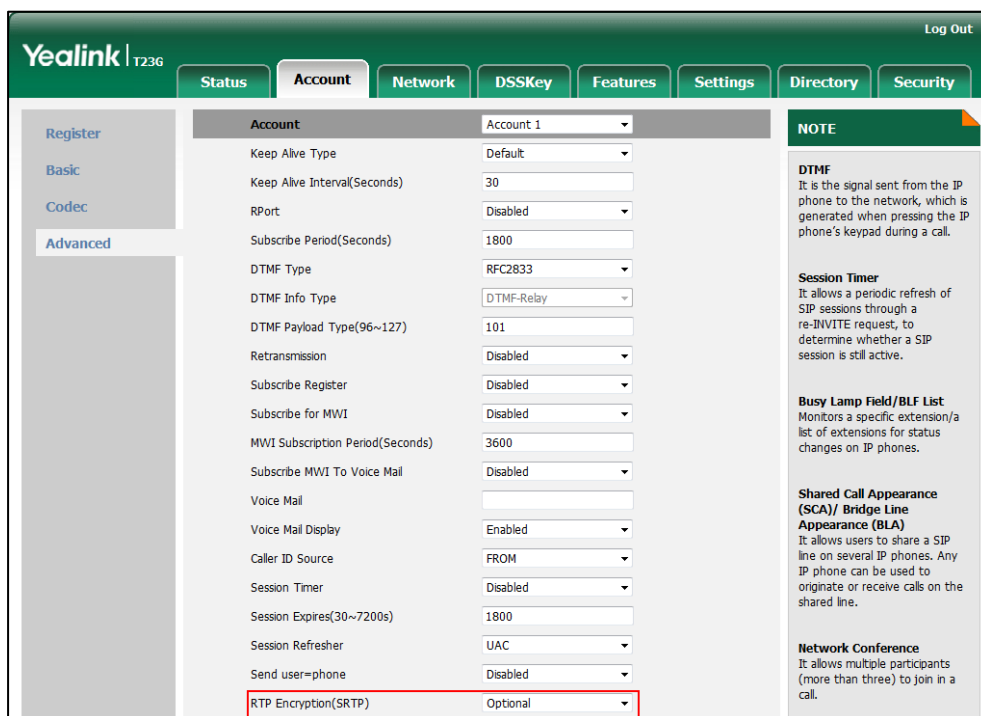

4. Click **Confirm** to accept the change.

Note

SRTP is not available on all servers. Contact your system administrator for more information.

SRTP is configurable via web user interface only.

Log Issues

How to export PCAP trace?

We may need you to provide a PCAP trace to help analyze your problem.

To export a PCAP trace via web user interface:

1. Click on **Settings->Configuration**.
2. Click **Start** to begin capturing signal traffic.
3. Recreate the error to be documented in the trace.
4. Click **Stop** to stop the capture.

- Click **Export** to open file download window, and then save the file to your local system.

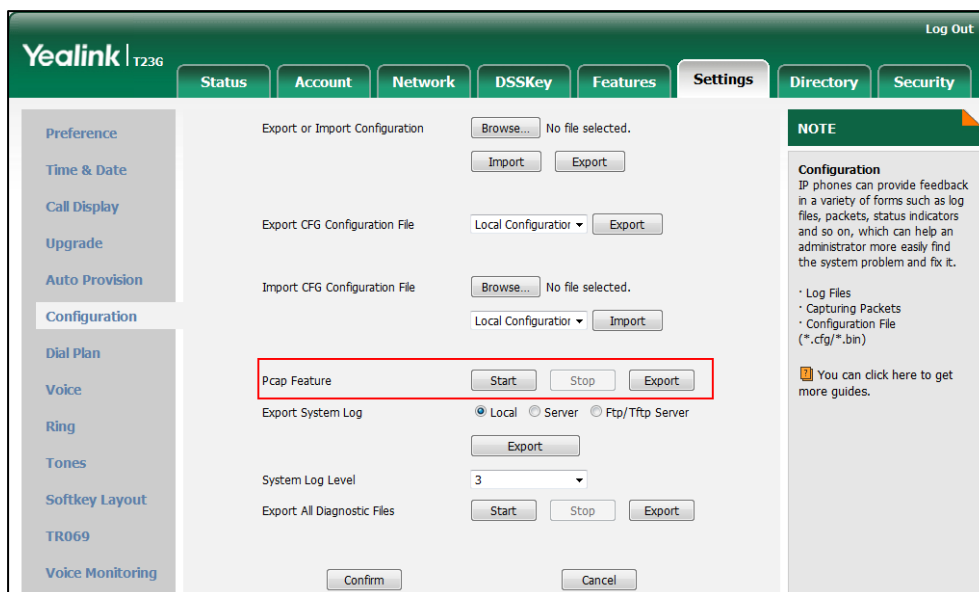

How to export system log?

We may need you to provide a system log to help analyze your problem.

To export the system log to a local PC via web user interface:

- Click on **Settings->Configuration**.
- Select **6** from the pull-down list of **System Log Level**.
The default system log level is "3".
- Click **Confirm** to accept the change.
- Mark the **Local** radio box in the **Export System Log** field.
- Reproduce the issue.

- Click **Export** to open the file download window, and then save the file to your local system.

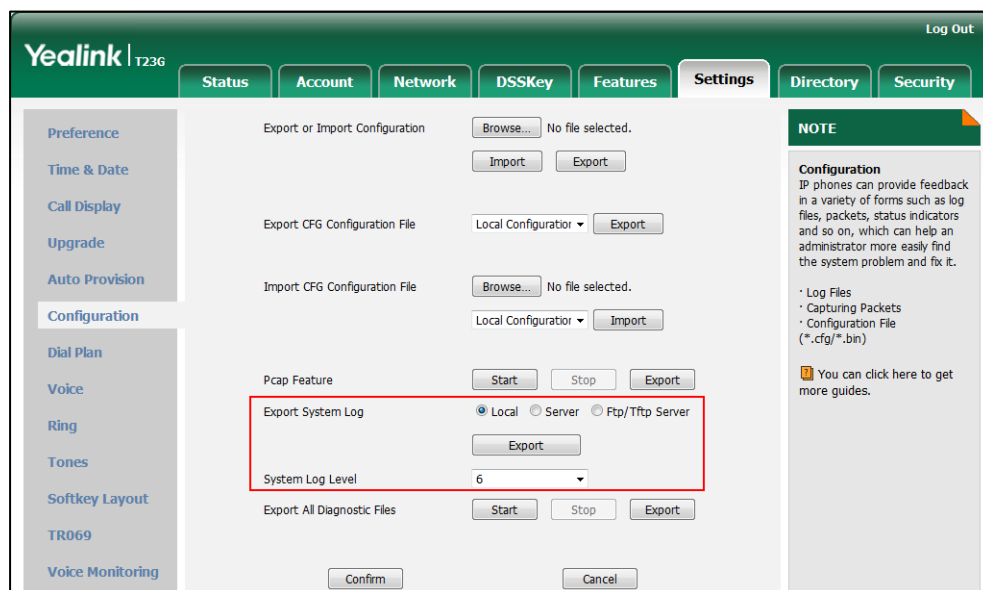

You can also export the system log to a syslog server. Contact your system administrator for more information.

Note

It is recommended to reset the syslog level to 3 after exporting the system syslog.

How to export all diagnostic files?

We may need you to provide three types of diagnostic files (including PCAP trace, system log and BIN configuration file) to help analyze your problem. You can export these files at a time.

To export all diagnostic files via web user interface:

- Click on **Settings->Configuration**.
- Click **Start** to begin capturing signal traffic.
The system log level will be automatically set to 6.
- Reproduce the issue.
- Click **Stop** to stop the capture.
The system log level will be reset to 3.

- Click **Export** to open file download window, and then save diagnostic files to your local system.

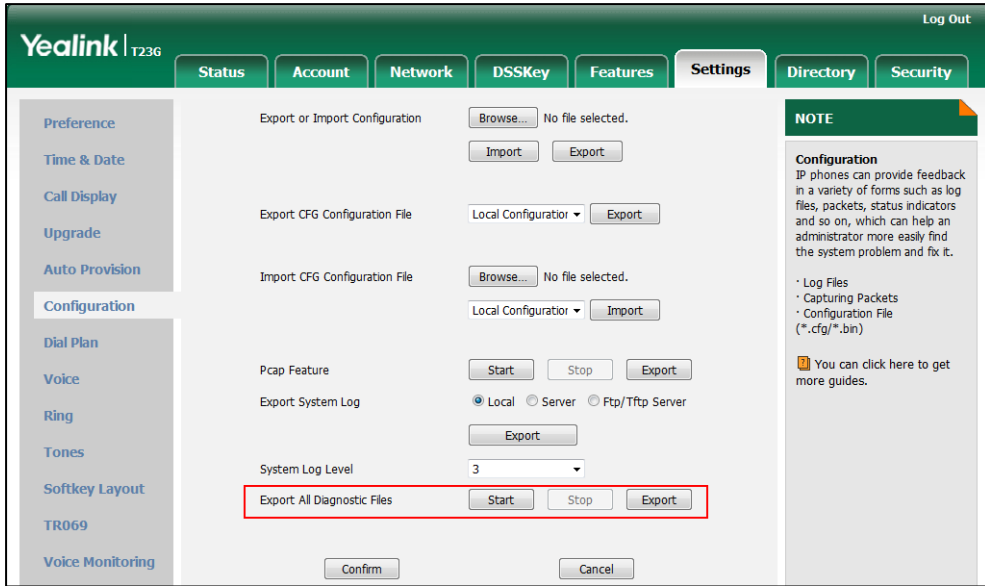

Note If the issue cannot be reproduced, just directly click **Export** to export all diagnostic files.

Reboot & Upgrade & Reset Issues

How to reboot the phone?

To reboot the phone via web user interface:

- Click on **Settings->Upgrade**.
- Click **Reboot** to reboot the IP phone.

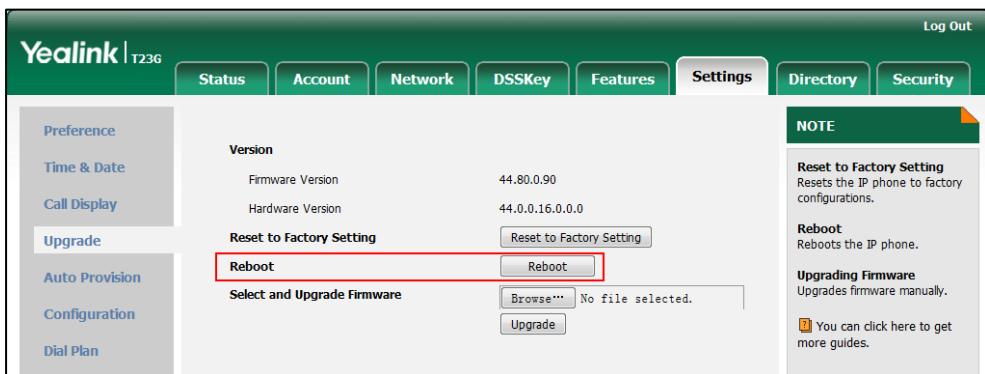

Note Any reboot of the IP phone may take a few minutes.

How to upgrade firmware?

To upgrade firmware via web user interface:

1. Click on **Settings->Upgrade**.
2. Click **Browse** to locate the required firmware from your local system.

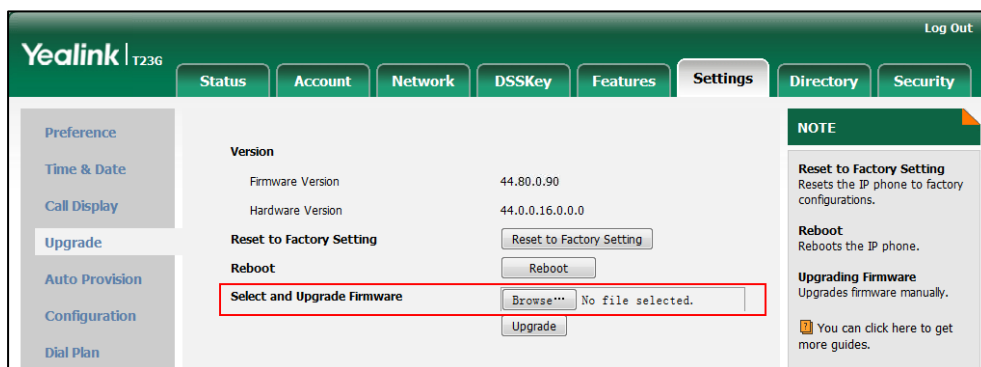

3. Click **Upgrade** to upgrade the firmware.

The web user interface prompts "Firmware of the SIP Phone will be updated. It will take 5 minutes to complete. Please don't power off!".

4. Click **OK** to confirm upgrading.

How to reset the phone?

Reset the phone to factory configurations after you have tried all troubleshooting suggestions but do not solve the problem. You need to note that all customized settings will be overwritten after reset.

To reset the phone via phone user interface:

1. Press **Menu->Settings->Advanced Settings** (default password: admin) ->**Reset to Factory**.
2. Press the **Enter** soft key.

The LCD screen prompts the following warning:

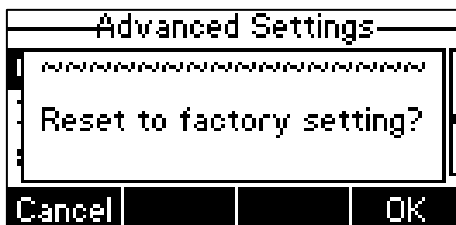

3. Press the **OK** soft key.

The LCD screen prompts “Resetting to factory,please wait...”.

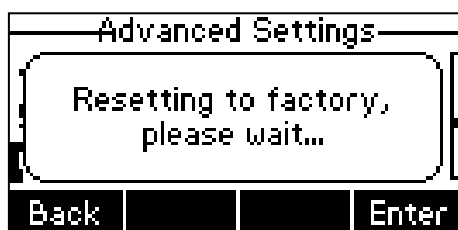

The LCD screen prompts “Welcome Initializing...please wait”.

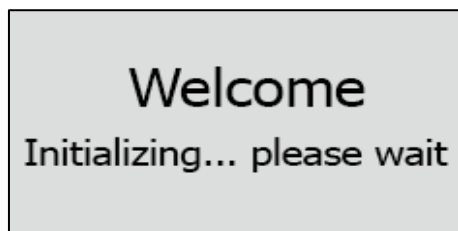

The phone will be reset to factory settings successfully after startup.

Note

Reset of your phone may take a few minutes. Do not power off until the phone has started up successfully.

Regulatory Notices

Service Agreements

Contact your Yealink Authorized Reseller for information about service agreements applicable to your product.

Limitations of Liability

TO THE FULL EXTENT ALLOWED BY LAW, YEALINK EXCLUDES FOR ITSELF AND ITS SUPPLIERS ANY LIABILITY, WHETHER BASED IN CONTRACT OR TORT (INCLUDING NEGLIGENCE), FOR INCIDENTAL, CONSEQUENTIAL, INDIRECT, SPECIAL, OR PUNITIVE DAMAGES OF ANY KIND, OR FOR LOSS OF REVENUE OR PROFITS, LOSS OF BUSINESS, LOSS OF INFORMATION OR DATA, OR OTHER FINANCIAL LOSS ARISING OUT OF OR IN CONNECTION WITH THE SALE, INSTALLATION, MAINTENANCE, USE, PERFORMANCE, FAILURE, OR INTERRUPTION OF ITS PRODUCTS, EVEN IF YEALINK OR ITS AUTHORIZED RESELLER HAS BEEN ADVISED OF THE POSSIBILITY OF SUCH DAMAGES, AND LIMITS ITS LIABILITY TO REPAIR, REPLACEMENT, OR REFUND OF THE PURCHASE PRICE PAID, AT YEALINK'S OPTION. THIS DISCLAIMER OF LIABILITY FOR DAMAGES WILL NOT BE AFFECTED IF ANY REMEDY PROVIDED HEREIN SHALL FAIL OF ITS ESSENTIAL PURPOSE.

Safety Instructions

Save these instructions. Read these safety instructions before use!

The following basic safety precautions should always be followed to reduce risk of fire, electrical shock, and other personal injury.

General Requirements

- Before you install and use the device, read the safety instructions carefully and observe the situation during operation.
- During the process of storage, transportation, and operation, please always keep the device dry and clean.
- During the process of storage, transportation, and operation, please avoid collision and crash of the device.
- Please attempt not to dismantle the device by yourself. In case of any discrepancy, please contact the appointed maintenance center for repair.
- Without prior written consent, no organization or individual is permitted to make any change to the structure or the safety design of the device. Yealink is under no circumstance liable to consequences or legal issues caused by such changes.
- Please refer to the relevant laws and statutes while using the device. Legal rights of others should be respected as well.

Environmental Requirements

- Place the device at a well-ventilated place. Do not expose the device under direct sunlight.
- Keep the device dry and free of dusts.
- Place the device on a stable and level platform.

- Please place no heavy objects on the device in case of damage and deformation caused by the heavy load.
- Keep at least 10 cm between the device and the closest object for heat dissipation.
- Do not place the device on or near any inflammable or fire-vulnerable object, such as rubber-made materials.
- Keep the device away from any heat source or bare fire, such as a candle or an electric heater.
- Keep the device away from any household appliance with strong magnetic field or electromagnetic field, such as a microwave oven or a refrigerator.

Operating Requirements

- Do not let a child operate the device without guidance.
- Do not let a child play with the device or any accessory in case of accidental swallowing.
- Please use the accessories provided or authorized by the manufacturer only.
- The power supply of the device shall meet the requirements of the input voltage of the device. Please use the provided surge protection power socket only.
- Before plugging or unplugging any cable, make sure that your hands are completely dry.
- Do not spill liquid of any kind on the product or use the equipment near water, for example, near a bathtub, washbowl, kitchen sink, wet basement or near a swimming pool.
- Do not tread on, pull, or over-bend any cable in case of malfunction of the device.
- During a thunderstorm, stop using the device and disconnect it from the power supply. Unplug the power plug and the Asymmetric Digital Subscriber Line (ADSL) twisted pair (the radio frequency cable) to avoid lightning strike.
- If the device is left unused for a rather long time, disconnect it from the power supply and unplug the power plug.
- When there is smoke emitted from the device, or some abnormal noise or smell, disconnect the device from the power supply, and unplug the power plug immediately. Contact the specified maintenance center for repair.
- Do not insert any object into equipment slots that is not part of the product or auxiliary product.
- Before connecting a cable, connect the grounding cable of the device first. Do not disconnect the grounding cable until you disconnect all other cables.

Cleaning Requirements

- Before cleaning the device, stop using it and disconnect it from the power supply.
- Use a piece of soft, dry and anti-static cloth to clean the device.
- Keep the power plug clean and dry. Using a dirty or wet power plug may lead to electric shock or other perils.

Appendix A - Time Zones

Time Zone	Time Zone Name
-11	Samoa
-10	United States-Hawaii-Aleutian, United States-Alaska-Aleutian
-9:30	French Polynesia
-9	United States-Alaska Time
-8	Canada(Vancouver,Whitehorse), Mexico(Tijuana,Mexicali), United States-Pacific Time
-7	Canada(Edmonton,Calgary), Mexico(Mazatlan,Chihuahua), United States-MST no DST, United States-Mountain Time
-6	Canada-Manitoba(Winnipeg), Chile(Easter Islands), Mexico(Mexico City,Acapulco), United States-Central Time
-5	Bahamas(Nassau), Canada(Montreal,Ottawa,Quebec), Cuba(Havana), United States-Eastern Time
-4:30	Venezuela(Caracas)
-4	Canada(Halifax,Saint John), Chile(Santiago), Paraguay(Asuncion), United Kingdom-Bermuda(Bermuda), United Kingdom(Falkland Islands), Trinidad&Tobago
-3:30	Canada-New Foundland(St.Johns)
-3	Argentina(Buenos Aires), Brazil(DST), Brazil(no DST), Denmark-Greenland(Nuuk)
-2:30	Newfoundland and Labrador
-2	Brazil(no DST)
-1	Portugal(Azores)
0	Denmark-Faroe Islands(Torshavn), GMT, Greenland, Ireland(Dublin), Morocco, Portugal(Lisboa,Porto,Funchal), Spain-Canary Islands(Las Palmas), United Kingdom(London)
+1	Albania(Tirane), Austria(Vienna), Belgium(Brussels), Caicos, Chad, Croatia(Zagreb), Czech Republic(Prague), Denmark(Kopenhagen), France(Paris), Germany(Berlin), Hungary(Budapest), Italy(Rome), Luxembourg(Luxembourg), Macedonia(Skopje), Namibia(Windhoek), Netherlands(Amsterdam), Spain(Madrid)
+2	Estonia(Tallinn), Finland(Helsinki), Gaza Strip(Gaza), Greece(Athens), Israel(Tel Aviv), Jordan(Amman), Latvia(Riga), Lebanon(Beirut), Moldova(Kishinev), Romania(Bucharest), Russia(Kaliningrad), Syria(Damascus), Turkey(Ankara), Ukraine(Kyiv, Odessa)
+3	East Africa Time, Iraq(Baghdad), Russia(Moscow)
+3:30	Iran(Teheran)
+4	Armenia(Yerevan), Azerbaijan(Baku), Georgia(Tbilisi), Kazakhstan(Aktau), Russia(Samara)
+4:30	Afghanistan(Kabul)
+5	Kazakhstan(Aqtobe), Kyrgyzstan(Bishkek), Pakistan(Islamabad), Russia(Chelyabinsk)
+5:30	India(Calcutta)
+5:45	Nepal(Katmandu)
+6	Kazakhstan(Astana, Almaty), Russia(Novosibirsk,Omsk)
+6:30	Myanmar(Naypyitaw)
+7	Russia(Krasnoyarsk), Thailand(Bangkok)
+8	Australia(Perth), China(Beijing), Russia(Irkutsk, Ulan-Ude), Singapore(Singapore)
+8:45	Eucla
+9	Japan(Tokyo), Korea(Seoul), Russia(Yakutsk,Chita)

Time Zone	Time Zone Name
+9:30	Australia(Adelaide), Australia(Darwin)
+10	Australia(Brisbane), Australia(Hobart), Australia(Sydney,Melbourne,Canberra), Russia(Vladivostok)
+10:30	Australia(Lord Howe Islands)
+11	New Caledonia(Noumea), Russia(Srednekolymsk Time)
+11:30	Norfolk Island
+12	New Zealand(Wellington,Auckland), Russia(Kamchatka Time)
+12:45	New Zealand(Chatham Islands)
+13	Tonga(Nukualofa)
+13:30	Chatham Islands
+14	Kiribati

Index

A

About This Guide [v](#)
 Accessing the Remote Phone Book [60](#)
 Account Management [75](#)
 Account Registration [75](#)
 Adding Contacts [50](#)
 Adding Groups [47](#)
 Administrator password [39](#)
 Advanced Phone Features [121](#)
 Anonymous Call [119](#)
 Anonymous Call Rejection [120](#)
 Answering Calls [90](#)
 Appendix A – Time Zones [177](#)
 Area Code [81](#)
 Audio Issues [167](#)
 Audio Settings [43](#)
 Auto Answer [93](#)
 Auto Redial [93](#)
 Automatic Call Distribution (ACD) [137](#)

B

Backlight [35](#)
 Basic Call Features [87](#)
 Basic Network Settings [28](#)
 Blacklist [57](#)
 BLF List [123](#)
 Block Out [82](#)
 Bridged Line Appearance (BLA) [152](#)
 Busy Lamp Field (BLF) [121](#)

C

Call Completion [95](#)
 Call Forward [102](#)
 Call History Management [61](#)
 Call Hold/Resume [97](#)
 Call Issues [167](#)
 Call Mute [96](#)
 Call Park [114](#)
 Call Pickup [115](#)
 Call Recording [125](#)
 Call Transfer [109](#)
 Call Waiting [111](#)
 CE Mark Warning [ii](#)
 Configuring an Access URL [59](#)
 Configuring BLA Feature on the IP Phone [153](#)
 Configuring SCA Feature on the IP Phone [140](#)
 Conference [111](#)

Contact Management [46](#)
 Contrast [36](#)
 Copyright [ii](#)
 Customizing Your Phone [35](#)

D

Declaration of Conformity [ii](#)
 Deleting Contacts [52](#)
 Deleting Groups [49](#)
 Dial-now [80](#)
 Dial Plan [77](#)
 Directory [46](#)
 Dual Headset [66](#)
 Display Issues [165](#)
 Do Not Disturb (DND) [98](#)
 Documentations [19](#)
 Dual Headset [66](#)
 DSS Keys [66](#)

E

Editing Contacts [52](#)
 Editing Groups [48](#)
 Emergency Number [83](#)
 Ending Calls [91](#)
 Entering Data and Editing Fields [30](#)

G

General Issues [165](#)
 General Settings [35](#)
 Getting Started [21](#)

H

Hardware Component Instructions [11](#)
 Headset Mode Activation/Deactivation [64](#)
 Headset Prior [65](#)
 Headset Use [64](#)
 Headset & Handset Issues [167](#)
 Hot Desking [127](#)
 Hotline [85](#)

I

Icon Instructions [13](#)
 Idle Screen [30](#)
 Importing/Exporting Contact lists [56](#)
 In This Guide [v](#)
 Incoming Intercom Calls [129](#)
 Intercom [128](#)

K

Key as Send 40

L

Language 36

LED Instructions 14

Limitation of Liability 175

Line Keys 66

Live Dialpad 84

Local Conference 111

Local Directory 47

Log Issues 169

Logo Customization 63

M

Messages 158

Message Waiting Indicator (MWI) 162

Multicast Paging 131

Multiple Line Keys per Account 77

Music on Hold 137

N

Network Conference 113

O

Outgoing Intercom Calls 128

Overview 11

Optional Accessories 22

P

Packaging Contents 21

Password Issues 166

Phone Initialization 26

Phone Installation 23

Phone Status 26

Phone User Interface 16

Placing Calls 88

Placing Calls to Contacts 53

Programmable Keys 74

Phone Lock 40

R

Reboot & Upgrade & Reset Issues 172

ReCall 96

Receiving RTP Stream 134

Recent Call In Dialing 91

Redialing Numbers 91

Registration 30

Regulatory Notices 175

Remote Phone Book 59

Replace Rule 78

Retrieving a Held Call 149

Ring Tones 44

S

Safety Instructions 175

Search Source List in Dialing 55

Searching for Contacts 54

Sending RTP Stream 131

Service Agreements 175

Shared Call Appearance (SCA) 139

Short Message Service (SMS) 158

Summary of Changes v

System Customizations 63

T

Table of Contents vii

Time and Date 37

Troubleshooting 165

U

User Interfaces 16

Using BLA Features on the IP Phone 156

Using Intercom 131

Using Multicast Paging 135

Using SCA Features on the IP Phone 146

V

Voice Mail 161

Volume 43

W

Warranty ii

Web User Interface 17

WEEE Warning iii